

SWAROVSKI



KAPUTT DESIGNED BY

Jean Paul
GAULTIER



NEW FOR FALL/WINTER 2016/17

**I ALWAYS FIND
BEAUTY IN
THINGS THAT
ARE ODD!
IMPERFECT
THEY ARE
MUCH MORE
INTERESTING.**



Jean Paul
GAULTIER

It all began with something perfect ...

When Jean Paul Gaultier, haute couture rebel and modern design legend, visited Swarovski headquarters in 2013, he was struck by the perfection of Swarovski crystal. Inspired to create a crystal design of his own, he felt that there was no way to make something perfect more perfect. There was only a way to make it new. And that was adding a touch of imperfection ...

KAPUTT PRODUCT FAMILY

DESIGNED BY JEAN PAUL GAULTIER

Once the idea was out there, the creative power of Jean Paul Gaultier and technical expertise of Swarovski joined forces to give birth to something new. It took them over a year of development and experimentation, but in the end the result was perfect. Or perfectly imperfect.

Aptly named "Kaputt" (the German word for "broken") this exciting new collection consists of two Pendants and three Fancy Stones in rich, shimmering metallic colors that riff on irregular forms, break with conventions and celebrate the appeal of being different and unpredictable.



A stroke of genius: Cut, color, facets, and even small details were defined, shaped, and approved by Jean Paul Gaultier himself.



DESIGNED BY

Jean Paul
GAULTIER

CRYSTAL SCARABAEUS GREEN

DESIGNED BY JEAN PAUL GAULTIER

Scintillating somewhere between the hypnotic, otherworldly shimmer of the scarab and the bright green of tarnished copper, Crystal Scarabaeus Green was developed as a perfect match for the Kaputt Collection. It, too, was a flash of inspiration from Jean Paul Gaultier, who closely followed the development of this stunning new effect with its green, blue and purple metallic luster.



The story goes that as a young man Jean Paul Gaultier frequently went past the opera house in Paris and was fascinated by the green coloring of the tarnished copper roof.



DESIGNED BY

Jean Paul
GAULTIER

Content

| | |
|----|------------------------------|
| 09 | Why Swarovski |
| 11 | Product Overview |
| 15 | Designer Editions |
| 21 | Round Stones |
| 22 | Fancy Stones & Settings |
| 24 | Beads |
| 26 | BeCharmed & Pavé |
| 30 | Crystal Pearls |
| 32 | Pendants |
| 35 | Flat Backs No Hotfix |
| 37 | Flat Backs Hotfix |
| 40 | Sew-On Articles |
| 42 | Self-adhesive Elements |
| 47 | Transfers |
| 58 | Synthetics Hotfix |
| 71 | Buttons, Fasteners & Zippers |
| 75 | Metal Trimmings |
| 83 | Crystal Mesh |
| 85 | Application Aids |

EXCELLENCE, THROUGH INNOVATION AND ORIGIN

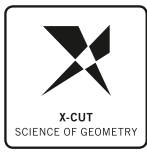

X-CUT
Advanced optical measurement and high-precision manufacturing deliver premium cuts characterized by unmatched brilliance.

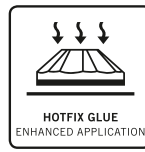

HOTFIX GLUE
The variable temperatures at which Hotfix glue can be activated enable the application of crystals on a broad range of textiles.



PLATINUM PRO
With its new advanced foiling technique, Swarovski has set a new standard in the lifespan of crystals.



CRYSTALS - MADE IN AUSTRIA
The combination of innovation with sustainability and respect for individual wellbeing means that quality is always assured.

PREMIUM, BY SERVICE AND DESIGN



DESIGN SERVICE
Throughout its global network of Design Centers, Swarovski offers exceptional service provided by the industry's best creative talent.



GLOBAL SERVICE
Swarovski's Global Service Network provides customers with dedicated personal assistance on a local level.



APPLICATION SERVICE
A comprehensive range of application services means customers benefit from the extensive experience of leading international experts, as well as internal specialists.



DESIGNER EDITIONS
Creative collaborations with top designers result in exclusive cuts and unique designs for Swarovski crystal.

COMPLIANCE, WITH INTEGRITY



ADVANCED CRYSTAL
Swarovski's patented lead-free* formula has changed the DNA of crystal while still offering the same sparkle, dependability, and variety for which Swarovski is famous.



CLEAR
Regular legal monitoring of chemical requirements and reasonable testing provide customers with the comfort of trust in Swarovski's products.

*Crystal glass and all other materials containing 0.009% lead or less.



OEKO-TEX
Oeko-Tex® Standard 100 Class II (direct contact with skin) certification creates confidence in chemical safety of textile applications.



Seal your success

Be part of our exclusive Ingredient Branding program

Product Overview

NEW CRYSTAL ELEMENTS

Designer Editions: Kaputt Fancy Stones & Kaputt Pendants

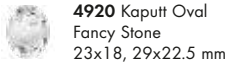

4920 Kaputt Oval
Fancy Stone
23x18, 29x22.5 mm



4921 Kaputt Oval
Fancy Stone
23x18, 29x22.5 mm



4921/S*
23x18, 29x22.5 mm



4922 Kaputt Fancy
Stone
28x24, 38x33 mm



4923 Kaputt Fancy
Stone
28x24, 38x33 mm



4923/S**
28x24, 38x33 mm



4924 Kaputt Baguette
Fancy Stone
23x9, 29x11.5 mm



4925 Kaputt Baguette
Fancy Stone
23x9, 29x11.5 mm



4925/S***
23x9, 29x11.5 mm



6910 Kaputt Oval
Pendant
26, 36 mm



6911 Kaputt Oval
Pendant
26, 36 mm



6912 Kaputt Pendant
28, 40 mm



6913 Kaputt Pendant
28, 40 mm

Fancy Stones & Settings



4331 Raindrop Fancy
Stone
11, 15, 20, 30 mm



4331/S
11, 15, 20, 30 mm

Beads



5045 Rondelle Bead
4, 6, 8 mm



5514 Pendulum Bead
8x5.5, 10x7 mm

BeCharmed & Pavé



80 912 BeCharmed
Pavé Column Bead
Spikes
11.5 mm Stainless St.



80 921 BeCharmed
Pavé Column Bead
13 mm Stainless St.



87 000 BeCharmed
Crystal Pearl Charm
8 mm



87 001 BeCharmed
Crystal Classic Charm
15x7.5 mm



87 002 BeCharmed
Crystal XILION
Triangle Charm
12 mm



87 003 BeCharmed
Pavé Ball Charm
8 mm



87 004 BeCharmed
Crystal Love Charm
12 mm



87 005 BeCharmed
Crystal Cross Charm
14 mm



87 006 BeCharmed
Crystal Spike Charm
18 mm



87 007 BeCharmed
Crystal Queen
Baguette Charm
13.5x6 mm



87 008 BeCharmed
Crystal Skull Charm
13 mm



87 009 BeCharmed
Crystal Greek Cross
Charm
14 mm

Pendants



67 452 Pavé
Teardrop Pendant
20, 30 mm



67 462 Pavé
Teardrop Pendant
Spikes
20, 30 mm



67 472 Pavé
Polygon Pendant
20, 30 mm



67 482 Pavé
Polygon Pendant
Spikes
20, 30 mm



67 492 Pavé Petal
Pendant
20, 30 mm



67 502 Pavé Petal
Pendant Spikes
20, 30 mm

Buttons, Fasteners & Zippers



3008 Classic Crystal
Button (4 holes)
12, 14, 18 mm

Flat Backs No Hotfix



2088/G XIRIUS Rose
partly frosted
SS 20, 34



2304 Raindrop Flat
Back
10x2.8, 14x3.9 mm

Flat Backs Hotfix



2078/G XIRIUS Rose
partly frosted
SS 20, 34



2304 Raindrop Flat
Back
10x2.8, 14x3.9 mm

UPGRADE AND NEW FORWARD-INTEGRATED ELEMENTS

Metal Trimmings



**53 301, 53 302,
53 303, 53 304**
Rose Pins

Synthetics

Graphic Fabric,
Fine Rocks & Rocks

* The Setting 4921/S for article 4921 can also be used for article 4920

** The Setting 4923/S for article 4923 can also be used for article 4922

*** The Setting 4925/S for article 4925 can also be used for article 4924

NEW EFFECT



Crystal Light
Chrome
(001 LTCH)

Designer Editions: Kaputt Fancy Stones & Kaputt Pendants

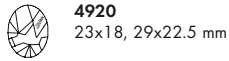

4920
23x18, 29x22.5 mm

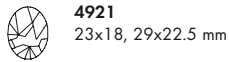

4921
23x18, 29x22.5 mm

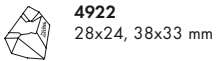

4922
28x24, 38x33 mm

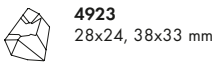

4923
28x24, 38x33 mm

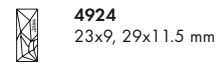

4924
23x9, 29x11.5 mm

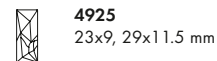

4925
23x9, 29x11.5 mm

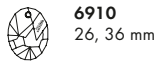

6910
26, 36 mm

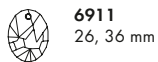

6911
26, 36 mm

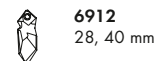

6912
28, 40 mm

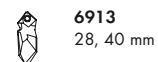

6913
28, 40 mm

Round Stones

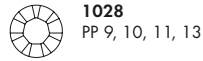

1028
PP 9, 10, 11, 13

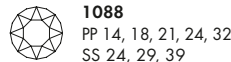

1088
PP 14, 18, 21, 24, 32
SS 24, 29, 39

Fancy Stones & Settings



4428
2, 3, 4 mm



4470
10, 12 mm

Beads

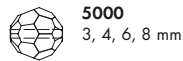

5000
3, 4, 6, 8 mm

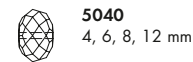

5040
4, 6, 8, 12 mm

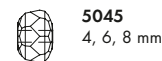

5045
4, 6, 8 mm

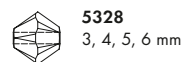

5328
3, 4, 5, 6 mm



5601
4, 6, 8 mm



5750
13, 19 mm

Pendants

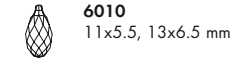

6010
11x5.5, 13x6.5 mm

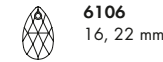

6106
16, 22 mm

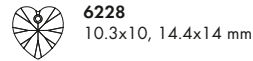

6228
10.3x10, 14.4x14 mm



6428
6, 8 mm

Flat Backs No Hotfix



2300
8x4.8, 10x6 mm

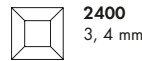

2400
3, 4 mm

Flat Backs Hotfix



2080/4
SS 10, 16, 34

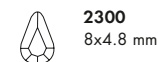

2300
8x4.8 mm

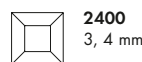

2400
3, 4 mm

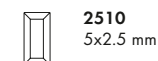

2510
5x2.5 mm

Sew-on Articles

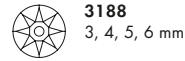

3188
3, 4, 5, 6 mm

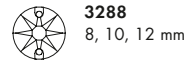

3288
8, 10, 12 mm

Transfers



1360 (with art. 1028)
PP 7, 12



1360 (with art. 1088)
PP 17

Crystal Inspirations Collection

13 204
13 208
13 209
13 211
13 190

Metal Trimmings

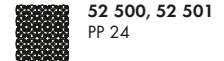

52 500, 52 501
PP 24

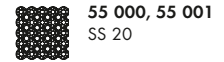

55 000, 55 001
SS 20

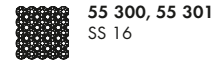

55 300, 55 301
SS 16

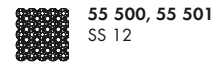

55 500, 55 501
SS 12

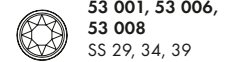

**53 001, 53 006,
53 008**
SS 29, 34, 39
PP 24



53 003
SS 29

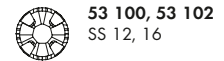

53 100, 53 102
SS 12, 16



53 203
SS 29

Buttons, Fasteners & Zippers



1792/100
17 mm



1811/100
12 mm



1811/120
15 mm

Crystal Mesh

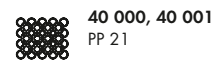

40 000, 40 001
PP 21

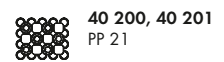

40 200, 40 201
PP 21

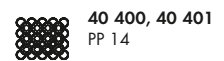

40 400, 40 401
PP 14

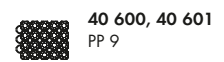

40 600, 40 601
PP 9

Please note that matt surfaces show a particular aging process which add an additional embellishment to the Kaputt stones. Generally matte surfaces become greasy and fingerprints appear easily. Clean gently with washing-up liquid or Isopropanol using a microfiber cloth. Please take care not to rub the surface when cleaning.

Product Overview

NEW EFFECT



Crystal Scarabaeus Green
designed by Jean Paul Gaultier
(001 SCGR)

Designer Editions: Kaputt Fancy Stones & Kaputt Pendants

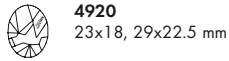

4920
23x18, 29x22.5 mm

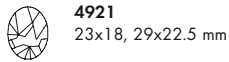

4921
23x18, 29x22.5 mm

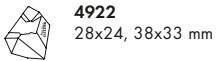

4922
28x24, 38x33 mm

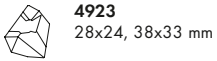

4923
28x24, 38x33 mm

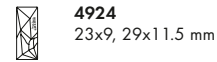

4924
23x9, 29x11.5 mm

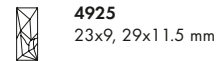

4925
23x9, 29x11.5 mm

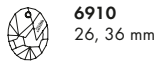

6910
26, 36 mm

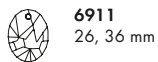

6911
26, 36 mm

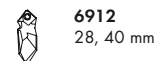

6912
28, 40 mm

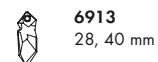

6913
28, 40 mm

Round Stones

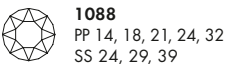

1088
PP 14, 18, 21, 24, 32
SS 24, 29, 39



1122
SS 39, 47
12, 14 mm

Fancy Stones & Settings

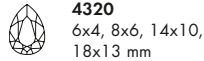

4320
6x4, 8x6, 14x10,
18x13 mm



4470
10, 12 mm

Beads

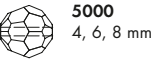

5000
4, 6, 8 mm

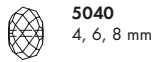

5040
4, 6, 8 mm

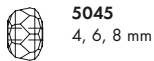

5045
4, 6, 8 mm

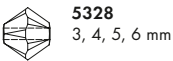

5328
3, 4, 5, 6 mm

Pendants

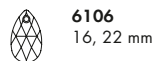

6106
16, 22 mm

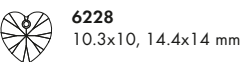

6228
10.3x10, 14.4x14 mm

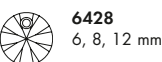

6428
6, 8, 12 mm

Flat Backs No Hotfix



2058
SS 5, 7, 9

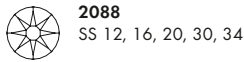

2088
SS 12, 16, 20, 30, 34

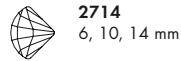

2714
6, 10, 14 mm

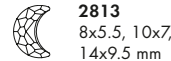

2813
8x5.5, 10x7,
14x9.5 mm

Flat Backs Hotfix



2038
SS 6, 8, 10

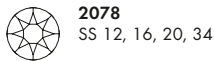

2078
SS 12, 16, 20, 34



2080/4
SS 10, 16, 34



2714
6, 10, 14 mm

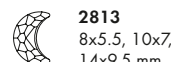

2813
8x5.5, 10x7,
14x9.5 mm

Sew-on Articles



3188
3, 4, 5 mm

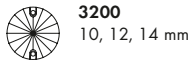

3200
10, 12, 14 mm



3288
8, 10, 12 mm

Transfers

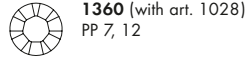

1360 (with art. 1028)
PP 7, 12



1360 (with art. 1088)
PP 17

Crystal Inspirations Collection

13 199
13 202
13 203
13 204
13 205
13 207
13 210
13 177
13 178
13 180
13 183
13 185
13 186
13 187
13 188
13 189
13 190
13 192

Buttons, Fasteners & Zippers



1791/120
17 mm



1792/100
17 mm



1810/539
9 mm



1810/547
11 mm



1810/120
13 mm



1810/140
15 mm



1811/100
12 mm



1811/120
15 mm

Metal Trimmings

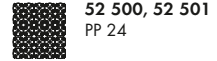

52 500, 52 501
PP 24

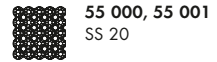

55 000, 55 001
SS 20

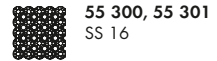

55 300, 55 301
SS 16



55 500, 55 501
SS 12

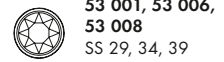

**53 001, 53 006,
53 008**
SS 29, 34, 39
PP 24



53 003
SS 29

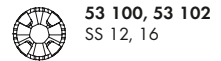

53 100, 53 102
SS 12, 16



53 203
SS 29

Crystal Mesh

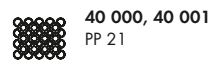

40 000, 40 001
PP 21

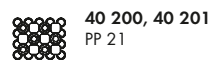

40 200, 40 201
PP 21

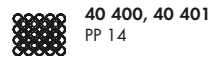

40 400, 40 401
PP 14

* The effect Scarabaeus Green spreads irregularly over the crystal product and - depending on the cut - creates a different yet perfectly harmonized surface every time.

** Please note that matt surfaces show a particular aging process which add an additional embellishment to the Kaputt stones. Generally matte surfaces become greasy and fingerprints appear easily. Clean gently with washing-up liquid or Isopropanol using a microfiber cloth. Please take care not to rub the surface when cleaning."

Product Overview

NEW CRYSTAL PEARL COLOR

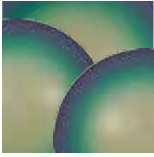

Crystal Scarabaeus
Green Pearl
(001 946)

BeCharmed & Pavé



5890
14 mm STEEL

Crystal Pearls



5810
3, 4, 5, 6, 8, 10, 12 mm



5817
6, 8, 10 mm



5840
6, 8, 10, 12 mm



5811
10, 12, 14 mm



5818
3, 4, 5, 6, 8, 10 mm



5860
10, 12 mm

LINE EXTENSIONS

New Sizes



5818
3 mm

New Colors & Effects for Crystal Fabric

Crystal Paradise Shine
Crystal & Crystal Moonlight

New Colors & Effects for Crystal Fine Rocks

Crystal
Erinite
Light Siam
Sunflower
Tangerine
Vintage Rose
Crystal Paradise Shine

New Colors for Ceralun

Dark Sapphire
Malachite
Red
Yellow
Shinning Green
Anthracite

New Spare Parts for CG-500 Cartridge Mixer

New Colors & Effects



3210
10x7, 16x11,
24x17 mm



3230
12x7, 18x10.5,
28x17 mm

New Colors & Effects for Crystal Rocks

Crystal
Erinite
Light Siam
Sunflower
Tangerine
Vintage Rose
Crystal Paradise Shine

New Colors for Transfers Metallics

Signal White
Grey Beige
Traffic Red
Blue Lilac
Azure Blue
Jet Black

KAPUTT DESIGNED BY JEAN PAUL GAULTIER

Design Story: While the whole world strives for perfection, Swarovski discovers the beauty of imperfection, guided and inspired by none other than design legend Jean Paul Gaultier. Together with Swarovski’s own trend, design and product management experts, Gaultier developed the spectacular Kaputt Collection exclusively for Swarovski. Like its name, the German word for “broken,” already suggests, the collection presents a technological innovation that deliberately breaks with convention. It celebrates the appeal of being different and unpredictable, which, according to the designer, is much more exciting than the precise and perfect.

Description: Broken and raw, but elegant at the same time, the Kaputt design captivates with distinctively irregular, partly unpolished, or frosted surfaces that give it an all natural, almost meteoritic appearance. It comes in rich, shimmering metallic colors as well as classics, such as Crystal and GSHA, and boasts the famous Jean Paul Gaultier logo as a laser engraving.

Look: In a world of flawless, artificial beauty, Kaputt mirrors the attractiveness of irregular, natural surfaces for a down-to-earth look that is both rock and chic.

4920 Kaputt Oval Fancy Stone ^{NEW!}

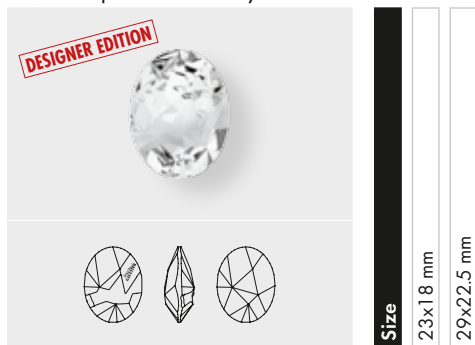

| Crystal | Size | 23x18 mm | 29x22.5 mm |
|---|------|----------|------------|
| Crystal F (001) | | ■ | ■ |
| Crystal Effects | | | |
| Transparent Effects | | | |
| Crystal AB F (001 AB) | | ■ | ■ |
| Crystal Golden Shadow F (001 GSHA) | | ■ | ■ |
| Crystal Red Magma F (001 REDM) | | ■ | ■ |
| Crystal Silver Night (001 SINI) | | ■ | ■ |
| Crystal Volcano F (001 VOL) | | ■ | ■ |
| Metallic Effects | | | |
| Crystal Dorado F (001 DOR) | | ■ | ■ |
| Crystal Light Chrome F (001 LTCH) ^{NEW!} | | ■ | ■ |
| Crystal Metallic Blue F (001 METBL) | | ■ | ■ |
| Crystal Metallic Light Gold F (001 MLGLD) | | ■ | ■ |
| Crystal Scarabaeus Green F (001 SCGR) ^{NEW!} | | ■ | ■ |

4921 Kaputt Oval Fancy Stone ^{NEW!}

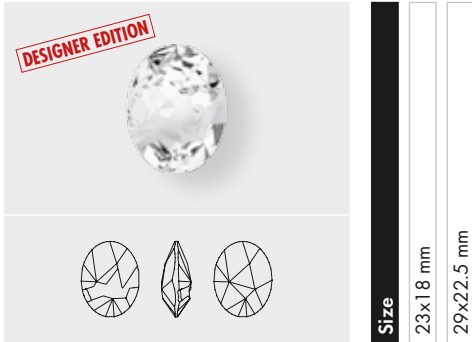

Size

23x18 mm

29x22.5 mm

Crystal

Crystal F (001)

Crystal Effects

Transparent Effects

Crystal AB F (001 AB)

Crystal Golden Shadow F (001 GSHA)

Crystal Red Magma F (001 REDM)

Crystal Silver Night (001 SINI)

Crystal Volcano F (001 VOL)

Metallic Effects

Crystal Dorado F (001 DOR)

Crystal Light Chrome F (001 LTCH) ^{NEW!}

Crystal Metallic Blue F (001 METBL)

Crystal Metallic Light Gold F (001 MLGLD)

Crystal Scarabaeus Green F (001 SCGR) ^{NEW!}

4921/S* ^{NEW!}

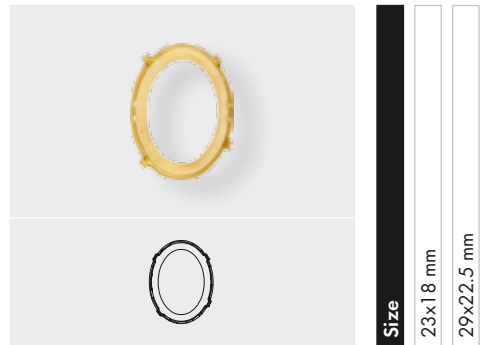

Size

23x18 mm

29x22.5 mm

Ring/Hole, Back Configuration

00 C = No ring/hole, closed

H2 O = 4 holes/2 each side, open



00 C



H2 O

4922 Kaputt Fancy Stone ^{NEW!}

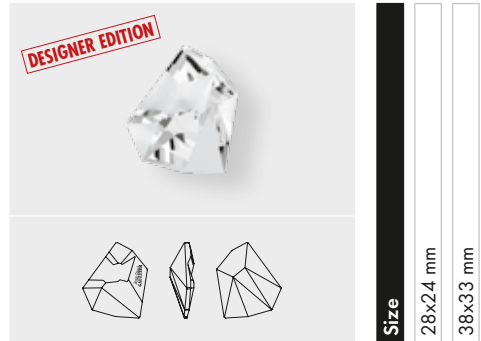

Size

28x24 mm

38x33 mm

Crystal

Crystal F (001)

Crystal Effects

Transparent Effects

Crystal AB F (001 AB)

Crystal Golden Shadow F (001 GSHA)

Crystal Red Magma F (001 REDM)

Crystal Silver Night (001 SINI)

Crystal Volcano F (001 VOL)

Metallic Effects

Crystal Dorado F (001 DOR)

Crystal Light Chrome F (001 LTCH) ^{NEW!}

Crystal Metallic Blue F (001 METBL)

Crystal Metallic Light Gold F (001 MLGLD)

Crystal Scarabaeus Green F (001 SCGR) ^{NEW!}

* The Setting 4921/S for article 4921 can also be used for article 4920.

4923 Kaputt Fancy Stone ^{NEW!}

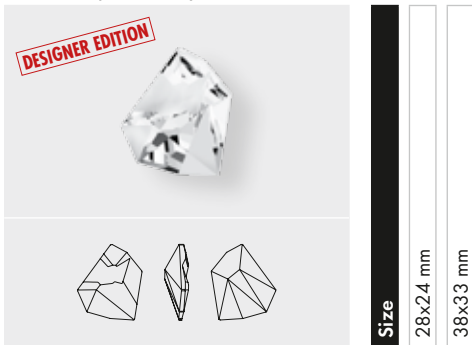

Crystal

Crystal F (001)

Crystal Effects

Transparent Effects

Crystal AB F (001 AB)

Crystal Golden Shadow F (001 GSHA)

Crystal Red Magma F (001 REDM)

Crystal Silver Night (001 SINI)

Crystal Volcano F (001 VOL)

Metallic Effects

Crystal Dorado F (001 DOR)

Crystal Light Chrome F (001 LTCH) ^{NEW!}

Crystal Metallic Blue F (001 METBL)

Crystal Metallic Light Gold F (001 MLGLD)

Crystal Scarabaeus Green F (001 SCGR) ^{NEW!}

4923/S* ^{NEW!}

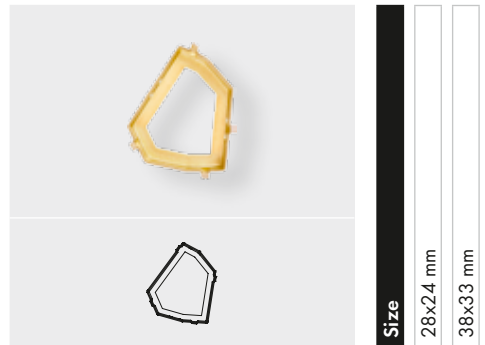

Ring/Hole, Back Configuration

00 C = No ring/hole, closed

H2 O = 4 holes/2 each side, open



4924 Kaputt Baguette Fancy Stone ^{NEW!}

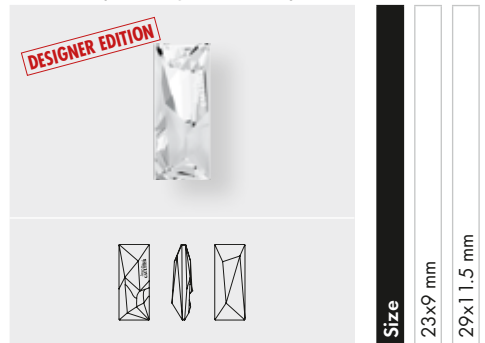

Crystal

Crystal F (001)

Crystal Effects

Transparent Effects

Crystal AB F (001 AB)

Crystal Golden Shadow F (001 GSHA)

Crystal Red Magma F (001 REDM)

Crystal Silver Night (001 SINI)

Crystal Volcano F (001 VOL)

Metallic Effects

Crystal Dorado F (001 DOR)

Crystal Light Chrome F (001 LTCH) ^{NEW!}

Crystal Metallic Blue F (001 METBL)

Crystal Metallic Light Gold F (001 MLGLD)

Crystal Scarabaeus Green F (001 SCGR) ^{NEW!}

* The Setting 4923/S for article 4923 can also be used for article 4922.

4925 Kaputt Baguette Fancy Stone ^{NEW!}

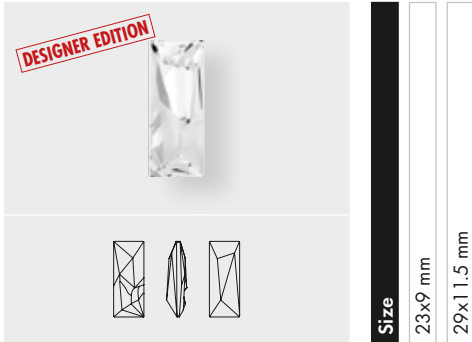

Crystal

Crystal F (001)

Crystal Effects

Transparent Effects

Crystal AB F (001 AB)

Crystal Golden Shadow F (001 GSHA)

Crystal Red Magma F (001 REDM)

Crystal Silver Night (001 SINI)

Crystal Volcano F (001 VOL)

Metallic Effects

Crystal Dorado F (001 DOR)

Crystal Light Chrome F (001 LTCH) ^{NEW!}

Crystal Metallic Blue F (001 METBL)

Crystal Metallic Light Gold F (001 MLGLD)

Crystal Scarabaeus Green F (001 SCGR) ^{NEW!}

4925/S* ^{NEW!}

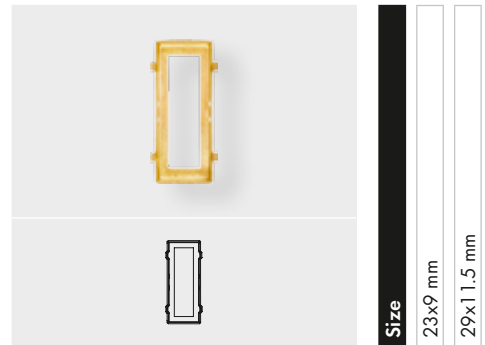

Ring/Hole, Back Configuration

00 C = No ring/hole, closed

H2 O = 4 holes/2 each side, open



6910 Kaputt Oval Pendant ^{NEW!}

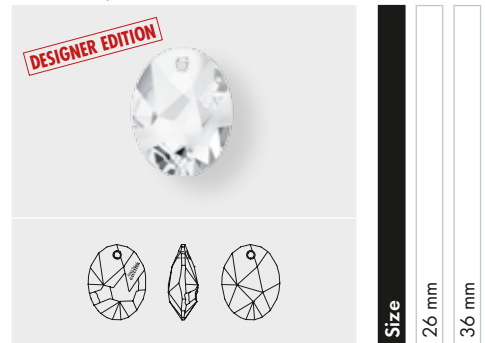

Crystal

Crystal (001)

Crystal Effects

Transparent Effects

Crystal AB (001 AB)

Crystal Golden Shadow (001 GSHA)

Crystal Red Magma (001 REDM)

Crystal Silver Night (001 SINI)

Crystal Volcano P (001 VOL)**

Metallic Effects

Crystal Dorado (001 DOR)

Crystal Light Chrome (001 LTCH) ^{NEW!}

Crystal Metallic Blue (001 METBL)

Crystal Metallic Light Gold (001 MLGLD)

Crystal Scarabaeus Green (001 SCGR) ^{NEW!}

* The Setting 4925/S for article 4925 can also be used for article 4924.

** For details about the "protective layer" please refer to the chapter 'Basic Information' in the Swarovski Crystal Collection 2014.

6911 Kaputt Oval Pendant ^{NEW!}

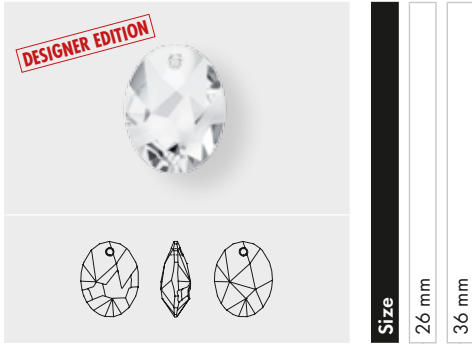

| Crystal | |
|---|--|
| Crystal (001) | <input type="checkbox"/> |
| Crystal Effects | |
| Transparent Effects | |
| Crystal AB (001 AB) | <input type="checkbox"/> |
| Crystal Golden Shadow (001 GSHA) | <input type="checkbox"/> |
| Crystal Red Magma (001 REDM) | <input type="checkbox"/> |
| Crystal Silver Night (001 SINI) | <input type="checkbox"/> |
| Crystal Volcano P (001 VOL)* | <input type="checkbox"/> |
| Metallic Effects | |
| Crystal Dorado (001 DOR) | <input type="checkbox"/> |
| Crystal Light Chrome (001 LTCH) | <input type="checkbox"/> ^{NEW!} |
| Crystal Metallic Blue (001 METBL) | <input type="checkbox"/> |
| Crystal Metallic Light Gold (001 MLGLD) | <input type="checkbox"/> |
| Crystal Scarabaeus Green (001 SCGR) | <input type="checkbox"/> ^{NEW!} |

6912 Kaputt Pendant ^{NEW!}



| Crystal | |
|---|--|
| Crystal (001) | <input type="checkbox"/> |
| Crystal Effects | |
| Transparent Effects | |
| Crystal AB (001 AB) | <input type="checkbox"/> |
| Crystal Golden Shadow (001 GSHA) | <input type="checkbox"/> |
| Crystal Red Magma (001 REDM) | <input type="checkbox"/> |
| Crystal Silver Night (001 SINI) | <input type="checkbox"/> |
| Crystal Volcano P (001 VOL)* | <input type="checkbox"/> |
| Metallic Effects | |
| Crystal Dorado (001 DOR) | <input type="checkbox"/> |
| Crystal Light Chrome (001 LTCH) | <input type="checkbox"/> ^{NEW!} |
| Crystal Metallic Blue (001 METBL) | <input type="checkbox"/> |
| Crystal Metallic Light Gold (001 MLGLD) | <input type="checkbox"/> |
| Crystal Scarabaeus Green (001 SCGR) | <input type="checkbox"/> ^{NEW!} |

* For details about the "protective layer" please refer to the chapter 'Basic Information' in the Swarovski Crystal Collection 2014.

6913 Kaputt Pendant ^{NEW!}

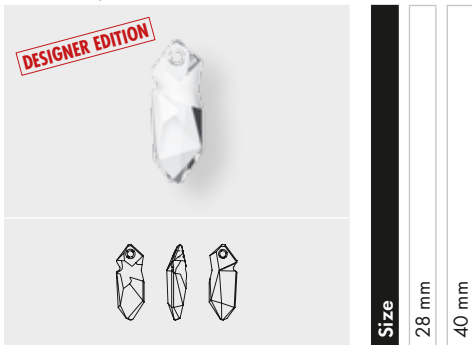

Crystal

Crystal (001)

Crystal Effects

Transparent Effects

Crystal AB (001 AB)

Crystal Golden Shadow (001 GSHA)

Crystal Red Magma (001 REDM)

Crystal Silver Night (001 SINI)

Crystal Volcano P (001 VOL)*

Metallic Effects

Crystal Dorado (001 DOR)

Crystal Light Chrome (001 LTCH) ^{NEW!}

Crystal Metallic Blue (001 METBL)

Crystal Metallic Light Gold (001 MLGLD)

Crystal Scarabaeus Green (001 SCGR) ^{NEW!}

CRYSTAL SCARABAEUS GREEN DESIGNED BY JEAN PAUL GAULTIER

Design Story: Expressing his desire for an exclusive effect that would match his Kaputt Collection, haute couture icon Jean Paul Gaultier developed Crystal Scarabaeus Green together with a team of experts from Swarovski. For his effect he wanted this precise scintillating shade of green, combined with the mythological shimmer of the Egyptian scarab.

Description: Aptly named, Crystal Scarabaeus Green evokes the magic glow of the scarab, shimmering in green, blue, and purple with a metallic luster that combines bright and shadowy facets to create a stunningly graphic surface.

Look: With its beetle-like glow, Crystal Scarabaeus Green lends itself perfectly to nature-inspired and bold eco-designs. It powerfully mimics nature and sets a rebellious statement for any eco-warrior. However, its shiny surface also evokes an otherworldly appearance that echoes futuristic, stellar avant-garde looks. The metallic rainbow hue caters to the sporty sci-fi appeal that celebrates state-of-the-art technology and transports us into other dimensions.

* For details about the "protective layer" please refer to the chapter 'Basic Information' in the Swarovski Crystal Collection 2014.

Round Stones

Round Stones are loose crystal elements, most of which are pointed on the reverse side for easy application. The assortment features a wide variety of different cuts, the most innovative one is the gemstone-like XIRIUS Chaton.

1028 XILION Chaton

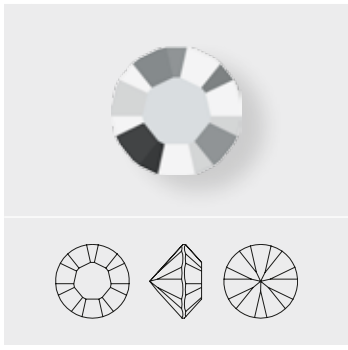

| Size |
|-------|
| PP 9 |
| PP 10 |
| PP 11 |
| PP 13 |

Crystal Effects

Metallic Effects

● Crystal Light Chrome F (001 LTCH) NEW!

1088 XIRIUS Chaton

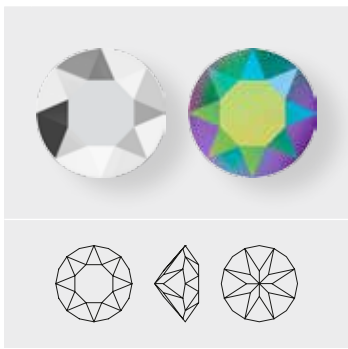

| Size |
|-------|
| PP 14 |
| PP 18 |
| PP 21 |
| PP 24 |
| PP 32 |
| SS 24 |
| SS 29 |
| SS 39 |

Crystal Effects

Metallic Effects

● Crystal Light Chrome F (001 LTCH) NEW!

● Crystal Scarabaeus Green F (001 SCGR) NEW!

1122 Rivoli Chaton

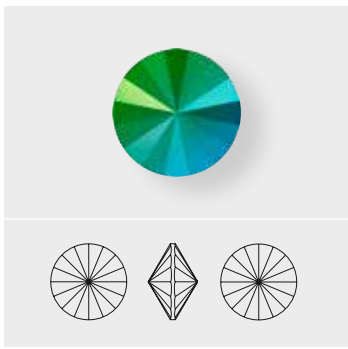

| Size |
|-------|
| SS 39 |
| SS 47 |
| 12 mm |
| 14 mm |

Crystal Effects

Metallic Effects

● Crystal Scarabaeus Green F (001 SCGR) NEW!

Fancy Stones & Settings

Fancy Stones are offered in a huge assortment of sizes and shapes, from classic to on-trend, with either a faceted or flat reverse side. Settings are each specifically tailored to a Fancy Stone and allow for a myriad of application possibilities.

4320

Size

- 6x4 mm
- 8x6 mm
- 14x10 mm
- 18x13 mm

Crystal Effects

Metallic Effects

Crystal Scarabaeus Green F (001 SCGR) NEW!

4331 Raindrop Fancy Stone NEW!

Size

- 11 mm
- 15 mm
- 20 mm
- 30 mm

Crystal

Crystal F (001)

Colors

Plain Colors

- Blush Rose F (257)
- Denim Blue F (266)
- Jet (280)
- Tanzanite F (539)

Crystal Effects

Transparent Effects

- Crystal AB F (001 AB)
- Crystal Antique Pink F (001 ANTP)
- Crystal Blue Shade F (001 BLSH)
- Crystal Golden Shadow F (001 GSHA)
- Crystal Luminous Green F (001 LUMG)
- Crystal Silver Night (001 SINI)
- Crystal Silver Shade F (001 SSHA)

4331/S NEW!

Size

- 11 mm
- 15 mm
- 20 mm
- 30 mm

Ring/Hole, Back Configuration

00 C = No ring/hole, closed

H2 O = 4 holes/2 each side, open

00 C H2 O

Fancy Stones & Settings

4428

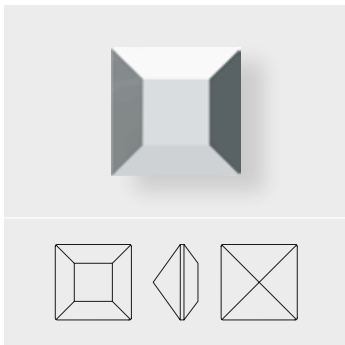

Size 2 mm

4428 XILLION Square Fancy Stone

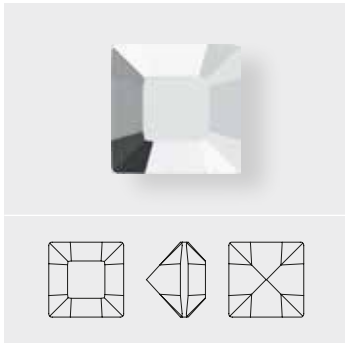

Size 3, 4 mm

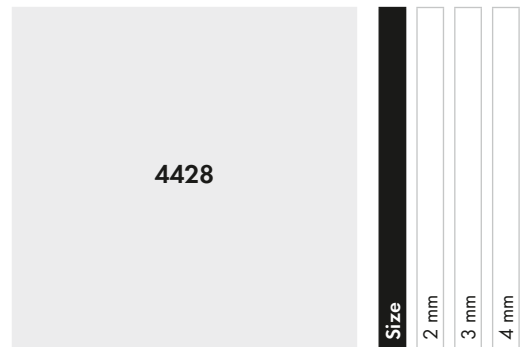

Crystal Effects

Metallic Effects

Crystal Light Chrome F (001 LTCH)

NEW!

Size

2 mm

3 mm

4 mm

4470

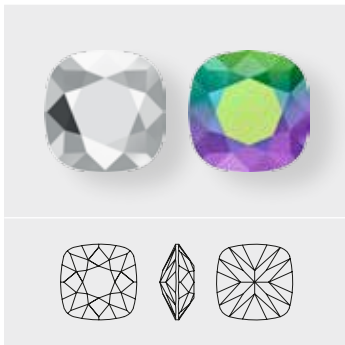

Size

10 mm

12 mm

Crystal Effects

Metallic Effects

Crystal Light Chrome F (001 LTCH)

NEW!

Crystal Scarabaeus Green F (001 SCGR)

NEW!

Beads

Beads offer the highest standard available on the market, with high-quality precision cutting and rounded hole edges for increased brilliance, durability and reduced wear on threads. They are available in the latest fashion colors for endless creativity.

5000

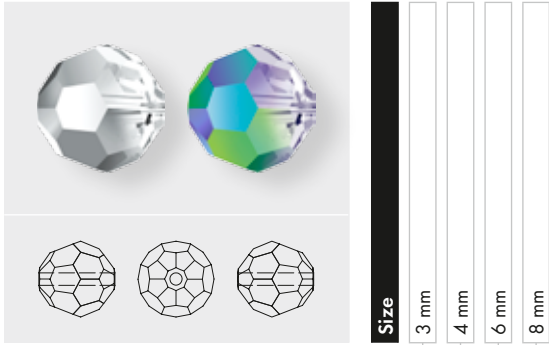

Size
3 mm
4 mm
6 mm
8 mm

Crystal Effects

Metallic Effects

| | | | | | |
|-------------------------------------|------|---|---|---|---|
| Crystal Light Chrome (001 LTCH) | NEW! | ■ | ■ | ■ | ■ |
| Crystal Scarabaeus Green (001 SCGR) | NEW! | ■ | ■ | ■ | ■ |

5040 Briolette Bead

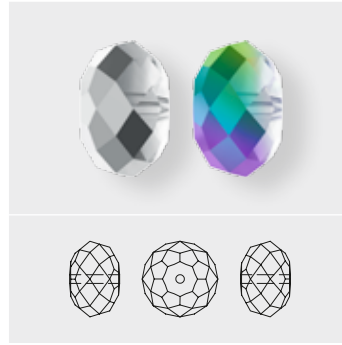

Size
4 mm
6 mm
8 mm
12 mm

Crystal Effects

Metallic Effects

| | | | | | |
|-------------------------------------|------|---|---|---|---|
| Crystal Light Chrome (001 LTCH) | NEW! | ■ | ■ | ■ | ■ |
| Crystal Scarabaeus Green (001 SCGR) | NEW! | ■ | ■ | ■ | ■ |

5045 Rondelle Bead ^{NEW!}

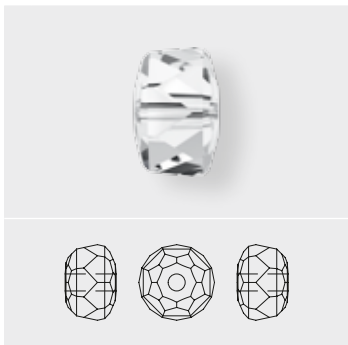

Size
4 mm
6 mm
8 mm

Crystal

| | | | |
|---------------|---|---|---|
| Crystal (001) | ■ | ■ | ■ |
|---------------|---|---|---|

Colors

Plain Colors

| | | | |
|--------------------|---|---|---|
| Denim Blue (266) | ■ | ■ | ■ |
| Emerald (205) | ■ | ■ | ■ |
| Fuchsia (502) | ■ | ■ | ■ |
| Jet (280) | ■ | ■ | ■ |
| Smoky Quartz (225) | ■ | ■ | ■ |

Opal Colors

| | | | |
|-----------------------|---|---|---|
| Rose Water Opal (395) | ■ | ■ | ■ |
| White Opal (234) | ■ | ■ | ■ |

Crystal Effects

Transparent Effects

| | | | |
|------------------------------------|---|---|---|
| Crystal AB (001 AB) | ■ | ■ | ■ |
| Crystal Paradise Shine (001 PARSH) | ■ | ■ | ■ |
| Crystal Silver Night (001 SINI) | ■ | ■ | ■ |

Crystal Effects

Metallic Effects

| | | | | |
|---------------------------------------|------|---|---|---|
| Crystal Light Chrome (001 LTCH) | NEW! | ■ | ■ | ■ |
| Crystal Metallic Sunshine (001 METSH) | | ■ | ■ | ■ |
| Crystal Scarabaeus Green (001 SCGR) | NEW! | ■ | ■ | ■ |

5328 XILION Bead

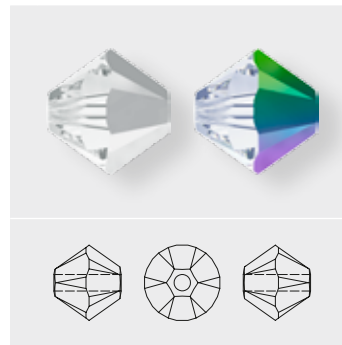

Size
3 mm
4 mm
5 mm
6 mm

Crystal Effects

Metallic Effects

| | | | | | |
|-------------------------------------|------|---|---|---|---|
| Crystal Light Chrome (001 LTCH) | NEW! | ■ | ■ | ■ | ■ |
| Crystal Light Chrome 2x (001 LTCH2) | NEW! | ■ | ■ | ■ | ■ |
| Crystal Scarabaeus Green (001 SCGR) | NEW! | ■ | ■ | ■ | ■ |

Beads

5514 Pendulum Bead ^{NEW!}

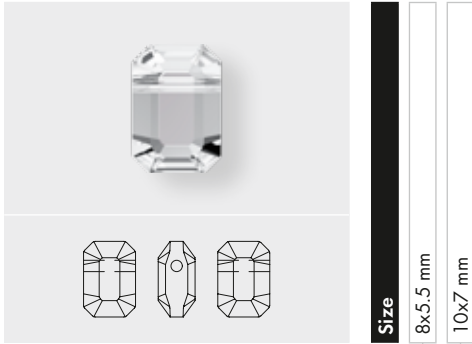

Size

8x5.5 mm

10x7 mm

Crystal

Crystal (001)

Colors

Plain Colors

Emerald (205)

Jet (280)

Smoky Quartz (225)

Opal Colors

Rose Water Opal (395)

White Opal (234)

Crystal Effects

Transparent Effects

Crystal AB (001 AB)

Crystal Paradise Shine (001 PARSH)

Crystal Silver Night (001 SINI)

Crystal Effects

Metallic Effects

Crystal Metallic Sunshine (001 METSH)

Crystal Patina

Crystal Gold Patina (001 GOLPA)

Crystal White Patina (001 WHIPA)

5601

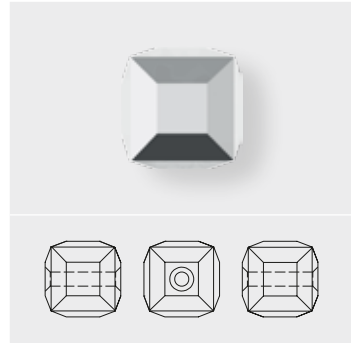

Size

4 mm

6 mm

8 mm

Crystal Effects

Metallic Effects

Crystal Light Chrome B (001 LTCHB) ^{NEW!}

5750 Skull Bead

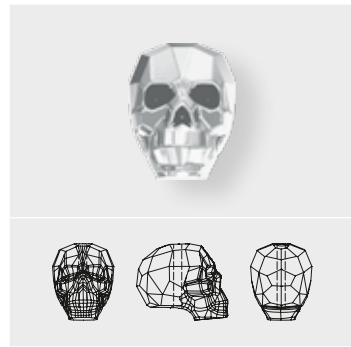

Size

13 mm

19 mm

Crystal Effects

Metallic Effects

Crystal Light Chrome (001 LTCH) ^{NEW!}

Crystal Light Chrome 2x (001 LTCH2) ^{NEW!}

BeCharmed & Pavé

The BeCharmed assortment comes in a brilliant, versatile array of colors, shapes, and effects. All products feature a high-quality stainless steel part with Swarovski branding, making the pieces true collectibles for individual, meaningful designs.

5890 Crystal BeCharmed Pearl

Size
14 mm STEEL

Colors

- Crystal Scarabaeus Green Pearl (001 946) NEW!

BECHARMED PAVÉ COLUMN BEAD

80 912 BeCharmed Pavé Column Bead Spikes NEW!

11.5 mm Stainless Steel

Colors

- Crystal Golden Shadow (001 GSXA)
- Crystal Metallic Light Gold (001 MLGLD)
- Pearl Silk (05)
- Crystal Silver Night (001 SINI)
- Jet (280)
- Black (02)
- White Opal (234)
- Crystal Moonlight (001 MOL)
- White (01)
- Crystal Silver Shade (001 SSXA)
- Crystal Chrom (001 CHRM)
- Silver (03)

80 921 BeCharmed Pavé Column Bead NEW!

13 mm Stainless Steel

Colors

- Vintage Rose (319)
- Vintage Rose (47)
- Crystal Golden Shadow (001 GSXA)
- Pearl Silk (05)
- Crystal Moonlight (001 MOL)
- White (01)
- Crystal Silver Night (001 SINI)
- Black (02)

BeCharmed & Pavé

BECHARMED CRYSTAL CHARMS

This is a true first in the Swarovski product range: The Crystal Charms, small all-time favorites already mounted on a Swarovski branded charm ring, come in ten different designs – a genuine cornucopia of crystals delights!

87 000 BeCharmed Crystal Pearl Charm ^{NEW!}

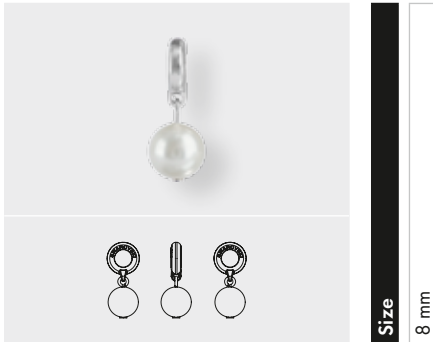

Size
8 mm

Colors

- Crystal Light Grey Pearl (001 616)
- Crystal Rosaline Pearl (001 294)
- Crystal White Pearl (001 650)

87 001 BeCharmed Crystal Classic Charm ^{NEW!}

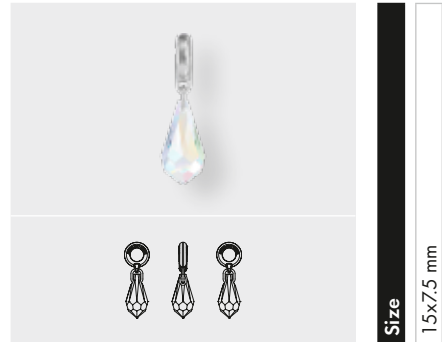

Size
1.5x7.5 mm

Colors

Plain Colors

- Light Turquoise (263)

Crystal Effects

Transparent Effects

- Crystal AB (001 AB)
- Crystal Lilac Shadow (001 LISH)

87 002 BeCharmed Crystal XILION Triangle Charm ^{NEW!}

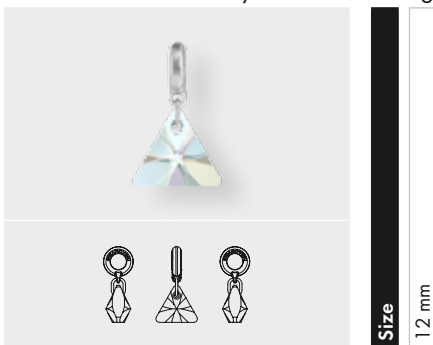

Size
12 mm

Crystal Effects

Transparent Effects

- Crystal AB (001 AB)
- Crystal Bermuda Blue P (001 BBL)*
- Crystal Silver Night (001 SINI)

87 003 BeCharmed Pavé Ball Charm ^{NEW!}

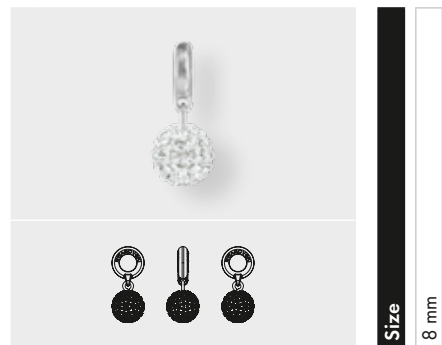

Size
8 mm

Crystal

- Crystal (001)
- White (01)

Colors

Plain Colors

- Light Rose (223)
- Rose (06)

Color Effects

Metallic Effects

- Jet Hematite (280 HEM)
- Black (02)

* For details about the "protective layer" please refer to the chapter 'Basic Information' in the Swarovski Crystal Collection 2014.

BeCharmed & Pavé

87 004 BeCharmed Crystal Love Charm ^{NEW!}

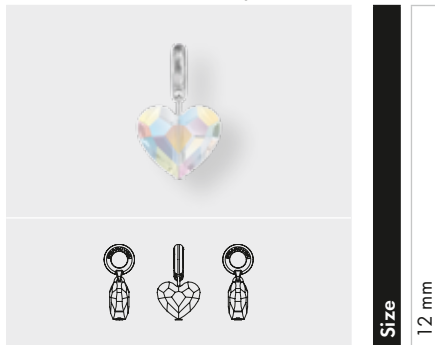

Size
12 mm

Crystal Effects

Transparent Effects

- Crystal AB (001 AB)
- Crystal Antique Pink (001 ANTP)
- Crystal Golden Shadow (001 GSHA)

87 005 BeCharmed Crystal Cross Charm ^{NEW!}

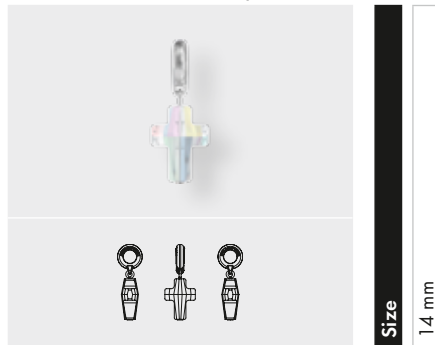

Size
14 mm

Crystal Effects

Transparent Effects

- Crystal AB (001 AB)
- Crystal Silver Night 2x (001 SINI2)

Metallic Effects

- Crystal Rose Gold 2x (001 ROGL2)

87 006 BeCharmed Crystal Spike Charm ^{NEW!}

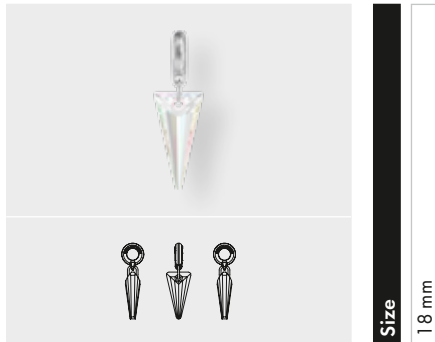

Size
18 mm

Crystal Effects

Transparent Effects

- Crystal AB (001 AB)
- Crystal Bermuda Blue P (001 BBL)*
- Crystal Silver Night (001 SINI)

87 007 BeCharmed Crystal Queen Baguette Charm ^{NEW!}

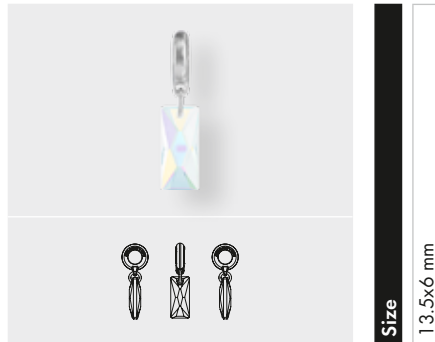

Size
13.5x6 mm

Crystal Effects

Transparent Effects

- Crystal AB (001 AB)
- Crystal Golden Shadow (001 GSHA)
- Crystal Silver Night (001 SINI)

* For details about the "protective layer" please refer to the chapter 'Basic Information' in the Swarovski Crystal Collection 2014.

BeCharmed & Pavé

87 008 BeCharmed Crystal Skull Charm ^{NEW!}

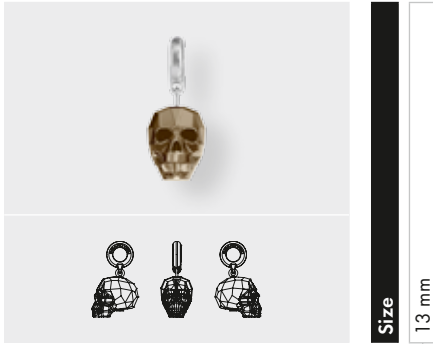

Colors

Plain Colors

● Jet (280)

Crystal Effects

Transparent Effects

● Crystal Silver Night 2x (001 SINI2)

Metallic Effects

● Crystal Metallic Light Gold 2x (001 MLGLD2)

87 009 BeCharmed Crystal Greek Cross Charm ^{NEW!}

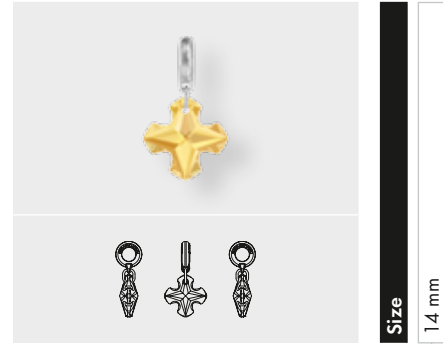

Crystal Effects

Transparent Effects

● Crystal Bermuda Blue P (001 BBL)*

● Crystal Silver Night (001 SINI)

Metallic Effects

● Crystal Metallic Sunshine (001 METSH)

* For details about the "protective layer" please refer to the chapter 'Basic Information' in the Swarovski Crystal Collection 2014.

Crystal Pearls

Crystal Pearls are perfect replicas of genuine pearls. They are made of a unique crystal core covered with an innovative pearl coating, which features a flawless, silky smooth, rounded surface, and are available in a variety of shapes, sizes, and colors.

5810 Crystal Round Pearl

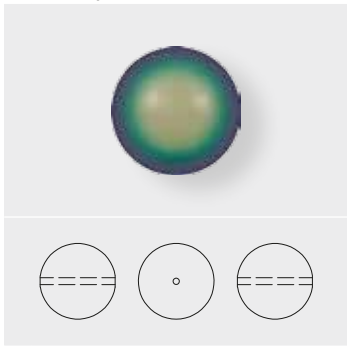

Product image and diagrams for 5810 Crystal Round Pearl. The top image shows a round pearl with a green-to-blue gradient. Below it are three circular diagrams: the first shows a pearl with a horizontal line through its center, the second shows a pearl with a small central dot, and the third shows a pearl with two horizontal lines through its center.

Size

| | | | | | | |
|------|------|------|------|------|-------|-------|
| 3 mm | 4 mm | 5 mm | 6 mm | 8 mm | 10 mm | 12 mm |
|------|------|------|------|------|-------|-------|

Colors

Crystal Scarabaeus Green Pearl (001 946) NEW!

5811 Crystal Pearl (large hole)

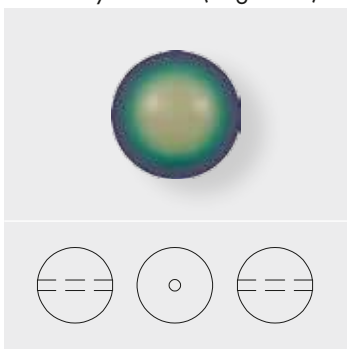

Product image and diagrams for 5811 Crystal Pearl (large hole). The top image shows a round pearl with a green-to-blue gradient. Below it are three circular diagrams: the first shows a pearl with a large hole and a horizontal line through its center, the second shows a pearl with a small central dot, and the third shows a pearl with two horizontal lines through its center.

Size

| | | |
|-------|-------|-------|
| 10 mm | 12 mm | 14 mm |
|-------|-------|-------|

Colors

Crystal Scarabaeus Green Pearl (001 946) NEW!

5817

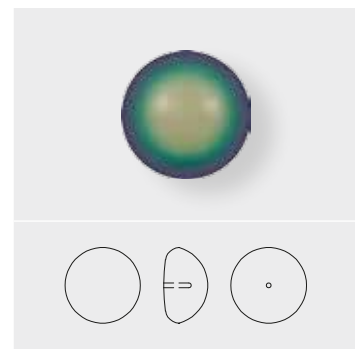

Product image and diagrams for 5817 Crystal Pearl. The top image shows a round pearl with a green-to-blue gradient. Below it are three circular diagrams: the first shows a pearl with a large hole, the second shows a pearl with a large hole and a horizontal line through its center, and the third shows a pearl with a small central dot.

Size

| | | |
|------|------|-------|
| 6 mm | 8 mm | 10 mm |
|------|------|-------|

Colors

Crystal Scarabaeus Green Pearl (001 946) NEW!

Crystal Pearls

5818

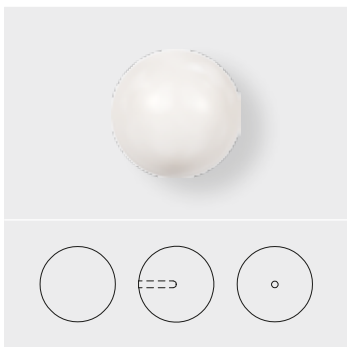

| Size | 3 mm | 4 mm | 5 mm | 6 mm | 8 mm | 10 mm |
|------|------|------|------|------|------|-------|
| | NEW! | | | | | |

Colors

- Crystal Cream Pearl (001 620)
- Crystal Creamrose Pearl (001 621)
- Crystal Dark Grey Pearl (001 617)
- Crystal Light Creamrose Pearl (001 618)
- Crystal Rosaline Pearl (001 294)
- Crystal Scarabaeus Green Pearl (001 946) NEW!
- Crystal White Pearl (001 650)

Gemcolors

- Crystal Mystic Black Pearl (001 335)

Pastelcolors

- Crystal Pastel Blue Pearl (001 966)
- Crystal Pastel Grey Pearl (001 968)
- Crystal Pastel Rose Pearl (001 944)
- Crystal Pastel Yellow Pearl (001 945)

5840 Crystal Baroque Pearl

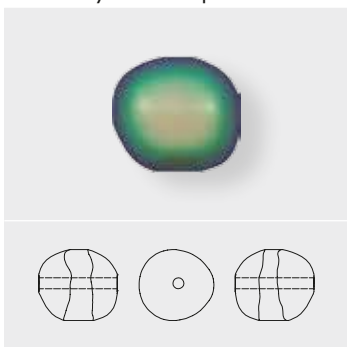

| Size | 6 mm | 8 mm | 10 mm | 12 mm |
|------|------|------|-------|-------|
| | NEW! | | | |

Colors

- Crystal Scarabaeus Green Pearl (001 946) NEW!

5860 Crystal Coin Pearl

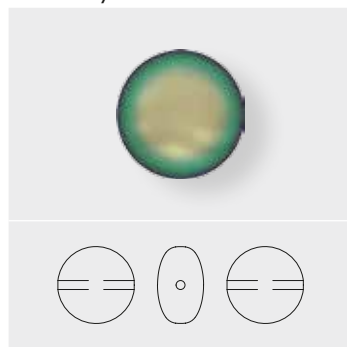

| Size | 10 mm | 12 mm |
|------|-------|-------|
| | NEW! | |

Colors

- Crystal Scarabaeus Green Pearl (001 946) NEW!

Pendants

Pendants are available in a large range of classical and avant-garde cuts and shapes. They are highly functional elements thanks to their easy application, with the hole on top requiring only a jump ring/pinch bail with a chain or cord to create beautiful designs.

6010 Briolette Pendant

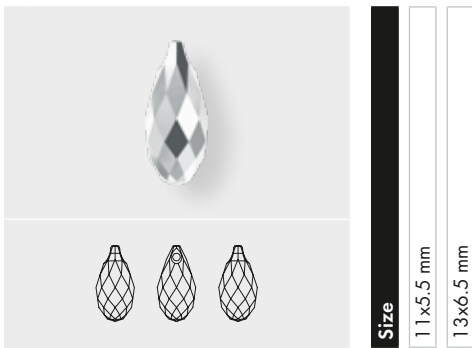

Size
11x5,5 mm
13x6,5 mm

Crystal Effects

Metallic Effects

● Crystal Light Chrome (001 LTCH) NEW!

6106 Pear-shaped Pendant

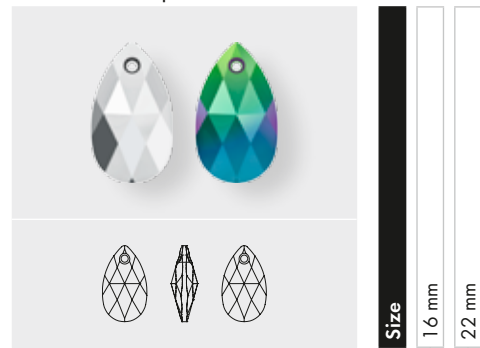

Size
16 mm
22 mm

Crystal Effects

Metallic Effects

● Crystal Light Chrome (001 LTCH) NEW!

● Crystal Scarabaeus Green (001 SCGR) NEW!

6228 XILION Heart Pendant

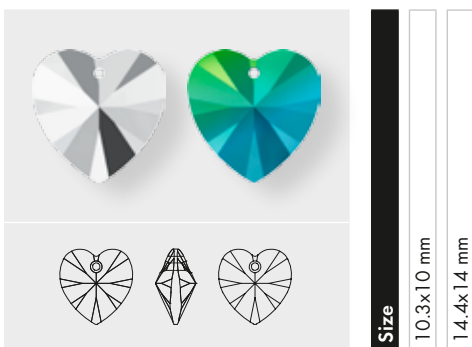

Size
10.3x10 mm
14.4x14 mm

Crystal Effects

Metallic Effects

● Crystal Light Chrome (001 LTCH) NEW!

● Crystal Scarabaeus Green (001 SCGR) NEW!

6428 XILION Pendant

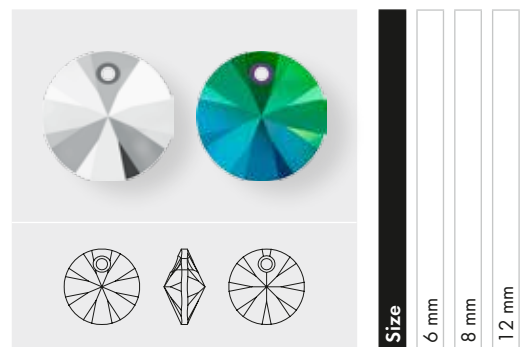

Size
6 mm
8 mm
12 mm

Crystal Effects

Metallic Effects

● Crystal Light Chrome (001 LTCH) NEW!

● Crystal Scarabaeus Green (001 SCGR) NEW!

Pendants

Pavé Pendants

67 452 Pavé Teardrop Pendant ^{NEW!}

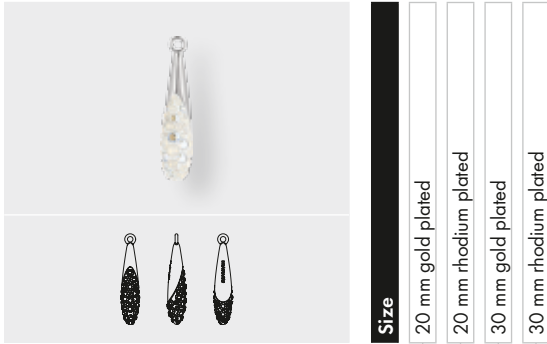

Colors

- Crystal Silver Night (001 SINI)
- Jet Hematite (280 HEM)
- Black (02)
- Crystal Silver Shade (001 SSHA)
- Black Diamond (215)
- Grey (19)
- White Opal F (234)
- Crystal Moonlight (001 MOL)
- White (01)
- Erinite F (360)
- Crystal Luminous Green F (001 LUMG)
- Dark Green (13)

| Size | 20 mm gold plated | 20 mm rhodium plated | 30 mm gold plated | 30 mm rhodium plated |
|-------------------------------------|-------------------|----------------------|-------------------|----------------------|
| Crystal Silver Night (001 SINI) | | | | |
| Jet Hematite (280 HEM) | | | | |
| Black (02) | | | | |
| Crystal Silver Shade (001 SSHA) | | | | |
| Black Diamond (215) | | | | |
| Grey (19) | | | | |
| White Opal F (234) | | | | |
| Crystal Moonlight (001 MOL) | | | | |
| White (01) | | | | |
| Erinite F (360) | | | | |
| Crystal Luminous Green F (001 LUMG) | | | | |
| Dark Green (13) | | | | |

67 462 Pavé Teardrop Pendant Spikes ^{NEW!}

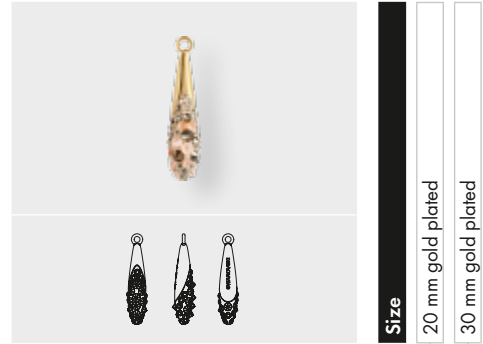

Colors

- Crystal Metallic Light Gold (001 MLGLD)
- Crystal Golden Shadow (001 GSHA)
- Pearl Silk (05)

| Size | 20 mm gold plated | 30 mm gold plated |
|---|-------------------|-------------------|
| Crystal Metallic Light Gold (001 MLGLD) | | |
| Crystal Golden Shadow (001 GSHA) | | |
| Pearl Silk (05) | | |

67 472 Pavé Polygon Pendant ^{NEW!}

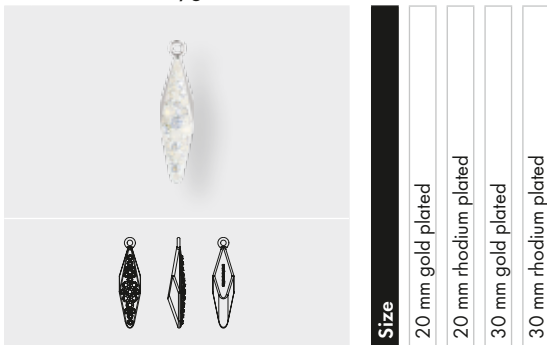

Colors

- Crystal Silver Night (001 SINI)
- Jet Hematite (280 HEM)
- Black (02)
- Crystal Silver Shade (001 SSHA)
- Black Diamond (215)
- Grey (19)
- White Opal F (234)
- Crystal Moonlight (001 MOL)
- White (01)
- Erinite F (360)
- Crystal Luminous Green F (001 LUMG)
- Dark Green (13)

| Size | 20 mm gold plated | 20 mm rhodium plated | 30 mm gold plated | 30 mm rhodium plated |
|-------------------------------------|-------------------|----------------------|-------------------|----------------------|
| Crystal Silver Night (001 SINI) | | | | |
| Jet Hematite (280 HEM) | | | | |
| Black (02) | | | | |
| Crystal Silver Shade (001 SSHA) | | | | |
| Black Diamond (215) | | | | |
| Grey (19) | | | | |
| White Opal F (234) | | | | |
| Crystal Moonlight (001 MOL) | | | | |
| White (01) | | | | |
| Erinite F (360) | | | | |
| Crystal Luminous Green F (001 LUMG) | | | | |
| Dark Green (13) | | | | |

67 482 Pavé Polygon Pendant Spikes ^{NEW!}

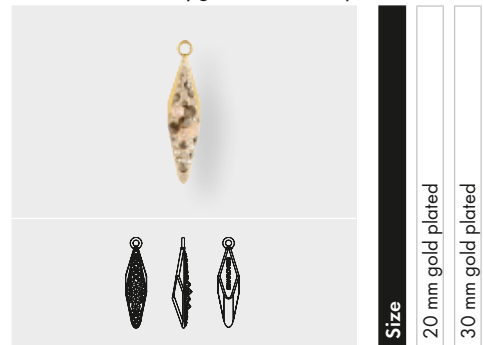

Colors

- Crystal Metallic Light Gold (001 MLGLD)
- Crystal Golden Shadow (001 GSHA)
- Pearl Silk (05)

| Size | 20 mm gold plated | 30 mm gold plated |
|---|-------------------|-------------------|
| Crystal Metallic Light Gold (001 MLGLD) | | |
| Crystal Golden Shadow (001 GSHA) | | |
| Pearl Silk (05) | | |

Pendants

67 492 Pavé Petal Pendant ^{NEW!}



| Size | 20 mm gold plated | 20 mm rhodium plated | 30 mm gold plated | 30 mm rhodium plated |
|------|-------------------|----------------------|-------------------|----------------------|
|------|-------------------|----------------------|-------------------|----------------------|

Colors

- Crystal Silver Night (001 SINI)
- Jet Hematite (280 HEM)
- Black (02)
- Crystal Silver Shade (001 SSHA)
- Black Diamond (215)
- Grey (19)
- White Opal F (234)
- Crystal Moonlight (001 MOL)
- White (01)
- Erinite F (360)
- Crystal Luminous Green F (001 LUMG)
- Dark Green (13)

Pavé Pendants

67 502 Pavé Petal Pendant Spikes ^{NEW!}

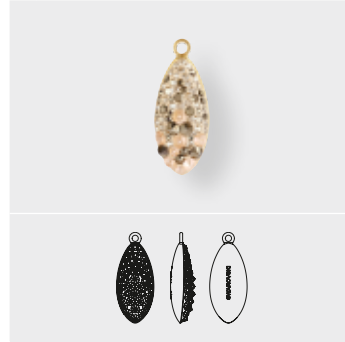

| Size | 20 mm gold plated | 30 mm gold plated |
|------|-------------------|-------------------|
|------|-------------------|-------------------|

Colors

- Crystal Metallic Light Gold (001 MLGLD)
- Crystal Golden Shadow (001 GSHA)
- Pearl Silk (05)

Flat Backs No Hotfix

Flat Backs No Hotfix are backed with platinum foiling for extra brilliance and protection, and for easy application to a variety of carrier materials using standard glues. They are available in a multitude of sizes, colors, shapes and cuts, with art. 2088 XIRIUS Rose being the "star" of the assortment.

2058 XILION Rose Enhanced

Size
SS 5
SS 7
SS 9

Crystal Effects
Metallic Effects

Crystal Scarabaeus Green F (001 SCGR) NEW!

2088 XIRIUS Rose

Size
SS 12
SS 16
SS 20
SS 30
SS 34

Crystal Effects
Metallic Effects

Crystal Scarabaeus Green F (001 SCGR) NEW!

2088/G XIRIUS Rose partly frosted NEW!

Size
SS 20
SS 34

Crystal
Crystal F (001)

Colors
Plain Colors
Jet F (280)

2300 Drop Flat Back

Size
8x4.8 mm
10x6 mm

Crystal Effects
Metallic Effects

Crystal Light Chrome F (001 LTCH) NEW!

Flat Backs No Hotfix

2304 Raindrop Flat Back ^{NEW!}

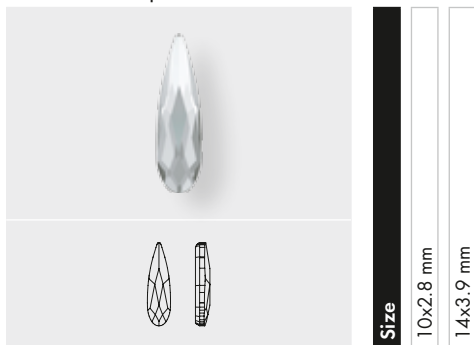

Size

10x2.8 mm

14x3.9 mm

Crystal

Crystal F (001)

Colors

Plain Colors

Blush Rose F (257)

Jet (280)

Light Siam F (227)

Crystal Effects

Transparent Effects

Crystal AB F (001 AB)

Crystal Blue Shade F (001 BLSH)

Crystal Golden Shadow F (001 GSHA)

Crystal Luminous Green F (001 LUMG)

Crystal Silver Night (001 SINI)

2400 Square Flat Back

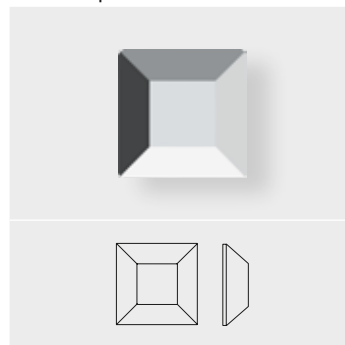

Size

3 mm

4 mm

Crystal Effects

Metallic Effects

Crystal Light Chrome F (001 LTCH) ^{NEW!}

2714 Fan Flat Back

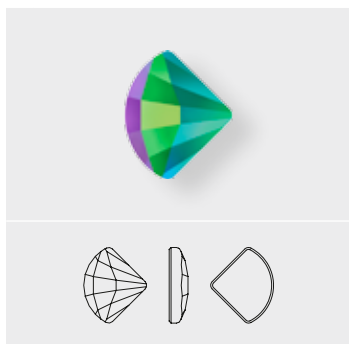

Size

6 mm

10 mm

14 mm

Crystal Effects

Metallic Effects

Crystal Scarabaeus Green F (001 SCGR) ^{NEW!}

2813 Moon Flat Back

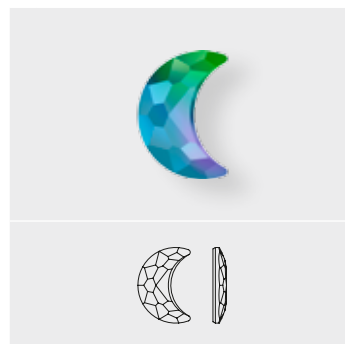

Size

8x5.5 mm

10x7 mm

14x9.5 mm

Crystal Effects

Metallic Effects

Crystal Scarabaeus Green F (001 SCGR) ^{NEW!}

Flat Backs Hotfix

Flat Backs Hotfix have a flat reverse side that has been pre-coated with a heat-sensitive glue. They can be easily applied to a large range of textile carrier materials. The most innovative single item in this product group is art. 2078 XIRIUS Rose.

2038 XILION Rose Hotfix

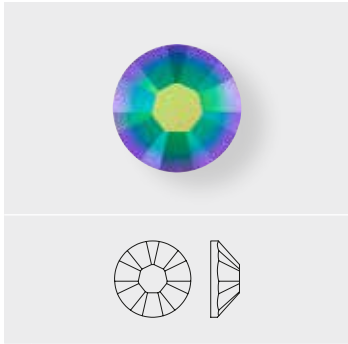

Size

- SS 6
- SS 8
- SS 10

Crystal Effects

Metallic Effects

Crystal Scarabaeus Green A HF (001 SCGR) NEW!

2078 XIRIUS Rose Hotfix

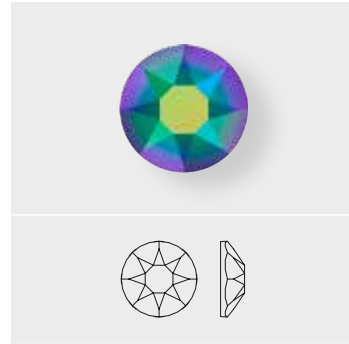

Size

- SS 12
- SS 16
- SS 20
- SS 34

Crystal Effects

Metallic Effects

Crystal Scarabaeus Green A HF (001 SCGR) NEW!

2078/G XIRIUS Rose partly frosted NEW!



Size

- SS 20
- SS 34

Crystal

- Crystal A HF (001)

Colors

Plain Colors

- Jet A HF (280)

2080/4 Cabochon



Size

- SS 10 (P3)
- SS 16 (P4)
- SS 34 (P7)

Crystal Effects

Metallic Effects

- Crystal Light Chrome HF (001 LTCH) NEW!
- Crystal Scarabaeus Green HF (001 SCGR) NEW!

Flat Backs Hotfix

2300 Drop Flat Back

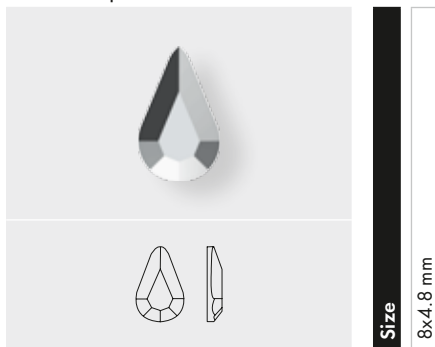

Size

8x4.8 mm

Crystal Effects

Metallic Effects

● Crystal Light Chrome M HF (001 LTCH) ^{NEW!}

2304 Raindrop Flat Back ^{NEW!}

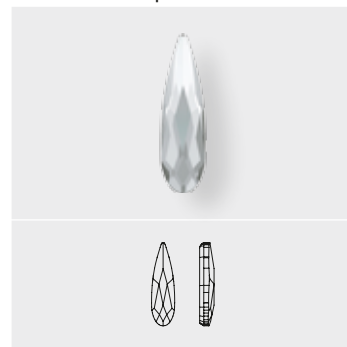

Size

10x2.8 mm

14x3.9 mm

Crystal

● Crystal M HF (001)

Colors

Plain Colors

● Blush Rose M HF (257)

● Jet M HF (280)

● Light Siam M HF (227)

Crystal Effects

Transparent Effects

● Crystal AB M HF (001 AB)

● Crystal Blue Shade M HF (001 BLSH)

● Crystal Golden Shadow M HF (001 GSHA)

● Crystal Luminous Green M HF (001 LUMG)

● Crystal Silver Night M HF (001 SINI)

2400 Square Flat Back

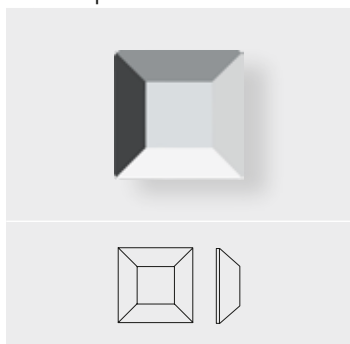

Size

3 mm

4 mm

Crystal Effects

Metallic Effects

● Crystal Light Chrome M HF (001 LTCH) ^{NEW!}

2510 Baguette Flat Back

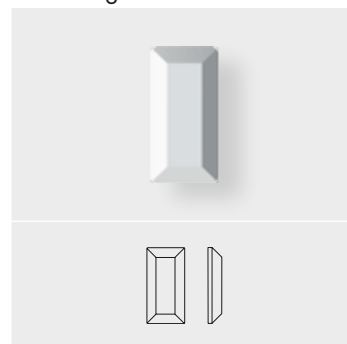

Size

5x2.5 mm

Crystal Effects

Metallic Effects

● Crystal Light Chrome M HF (001 LTCH) ^{NEW!}

Flat Backs Hotfix

2714 Fan Flat Back

Technical drawing showing the crystal from top, side, and back views.

| Size |
|-------|
| 6 mm |
| 10 mm |
| 14 mm |

Crystal Effects

Metallic Effects

Crystal Scarabaeus Green M HF (001 SCGR) NEW!

2813 Moon Flat Back

Technical drawing showing the crystal from top, side, and back views.

| Size |
|-----------|
| 8x5.5 mm |
| 10x7 mm |
| 14x9.5 mm |

Crystal Effects

Metallic Effects

Crystal Scarabaeus Green M HF (001 SCGR) NEW!

Sew-on Articles

Sew-on Articles are loose crystals that can be easily sewn on either by hand, or with a standard embroidery sewing machine. They come in one-, two-, or three-hole varieties, including round, oval, and triangle holes, all with rounded edges for thread protection.

3188 XIRIUS Lochrose

Technical drawing showing the crystal from top and side views.

| Size |
|------|
| 3 mm |
| 4 mm |
| 5 mm |
| 6 mm |

Crystal Effects

Metallic Effects

Crystal Light Chrome F (001 LTCH) NEW!

Crystal Scarabaeus Green F (001 SCGR) NEW!

3200 Rivoli Sew-on Stone

Technical drawing showing the crystal from top and side views.

| Size |
|-------|
| 10 mm |
| 12 mm |
| 14 mm |

Crystal Effects

Metallic Effects

Crystal Scarabaeus Green F (001 SCGR) NEW!

Sew-on Articles

3210 Oval Sew-on Stone

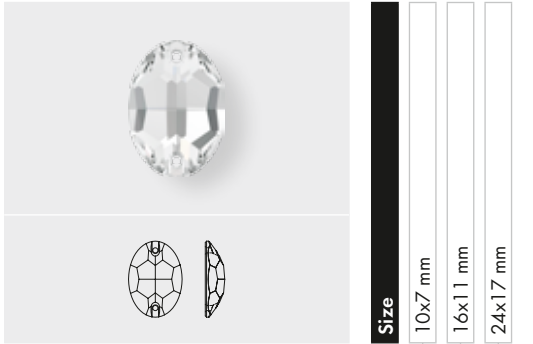

Size
 10x7 mm
 16x11 mm
 24x17 mm

Crystal Effects

Transparent Effects

Crystal Silver Night (001 SINI) NEW! NEW! NEW!

Metallic Effects

Crystal Light Chrome F (001 LTCH) NEW!

Crystal Metallic Sunshine F (001 METSH) NEW! NEW! NEW!

3230 Drop Sew-on Stone

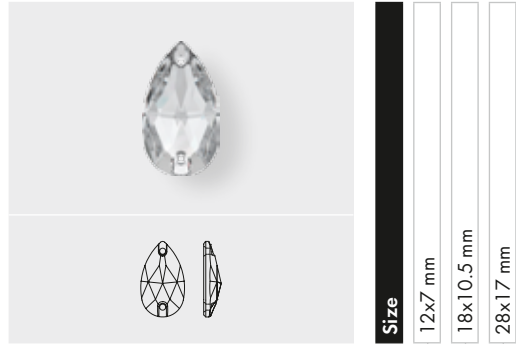

Size
 12x7 mm
 18x10.5 mm
 28x17 mm

Crystal Effects

Transparent Effects

Crystal Golden Shadow F (001 GSHA) NEW! NEW!

Crystal Silver Night (001 SINI) NEW! NEW! NEW!

Metallic Effects

Crystal Light Chrome F (001 LTCH) NEW!

3288 XIRIUS Sew-on Stone

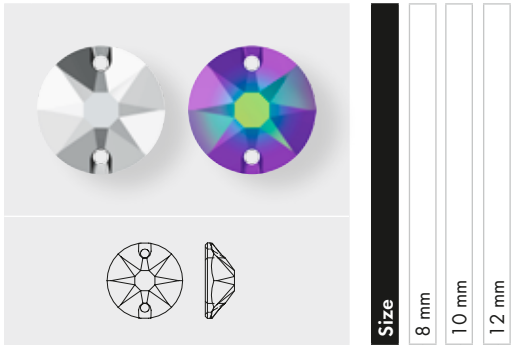

Size
 8 mm
 10 mm
 12 mm

Crystal Effects

Metallic Effects

Crystal Light Chrome F (001 LTCH) NEW!

Crystal Scarabaeus Green F (001 SCGR) NEW!

Product Details Crystal Elements

| Article Size | Packing Unit = Minimum Order Quantity in Pieces | Average Net Weight in Gram per Packing Unit Crystal (001) | Average Gross Weight in Gram per Packing Unit Crystal (001) |
|----------------|---|---|---|
| 4331 | | | |
| 11 mm | 180 | 18.84 | 29.04 |
| 15 mm | 96 | 20.35 | 49.95 |
| 20 mm | 48 | 21.17 | 46.37 |
| 30 mm | 24 | 36.02 | 58.39 |
| 4920 | | | |
| 23 x 18 mm | 15 | 63.30 | 88.03 |
| 29 x 22.5 mm | 8 | 65.72 | 86.13 |
| 4921 | | | |
| 23 x 18 mm | 15 | 63.30 | 88.03 |
| 29 x 22.5 mm | 8 | 65.72 | 86.13 |
| 4922 | | | |
| 28 x 24 mm | 8 | 38.85 | 59.98 |
| 38 x 33 mm | 6 | 69.78 | 93.36 |
| 4923 | | | |
| 28 x 24 mm | 8 | 38.85 | 59.98 |
| 38 x 33 mm | 6 | 69.78 | 93.36 |
| 4924 | | | |
| 23 x 9 mm | 20 | 37.60 | 60.20 |
| 29 x 11.5 mm | 12 | 49.08 | 69.68 |
| 4925 | | | |
| 23 x 9 mm | 20 | 37.60 | 60.20 |
| 29 x 11.5 mm | 12 | 49.08 | 69.68 |
| 5045 | | | |
| 4 mm | 540 | 36.09 | 46.29 |
| 6 mm | 288 | 60.74 | 70.94 |
| 8 mm | 216 | 117.50 | 145.90 |
| 5514 | | | |
| 8 x 5.5 mm | 144 | 42.73 | 67.83 |
| 10 x 7 mm | 96 | 48.86 | 70.70 |
| 5818 | | | |
| 3 mm | 1,000 | 42.00 | 52.00 |
| 6910 | | | |
| 26 mm | 20 | 141.28 | 165.32 |
| 36 mm | 9 | 150.39 | 180.53 |
| 6911 | | | |
| 26 mm | 20 | 141.28 | 165.32 |
| 36 mm | 9 | 150.39 | 180.53 |
| 6912 | | | |
| 28 mm | 15 | 36.90 | 62.74 |
| 40 mm | 8 | 58.24 | 80.45 |
| 6913 | | | |
| 28 mm | 15 | 36.90 | 62.74 |
| 40 mm | 8 | 58.24 | 80.45 |
| 2304 | | | |
| 10 x 2.8 mm | 180 | 10.25 | 20.45 |
| 14 x 3.9 mm | 96 | 13.10 | 36.28 |
| 2304 HF | | | |
| 10 x 2.8 mm | 180 | 10.25 | 20.45 |
| 14 x 3.9 mm | 96 | 13.10 | 36.28 |

Self-adhesive Elements such as Crystal-it, Crystal Fabric-it, Crystaltex-it Chaton or Crystal Rocks-it are eye-catching and innovative products that come ready-to-apply. They are pressure sensitive and self-adhesive and create elegant, romantic or sporty designs.

NEW EFFECTS FOR CRYSTAL FABRIC BANDINGS AND MOTIFS

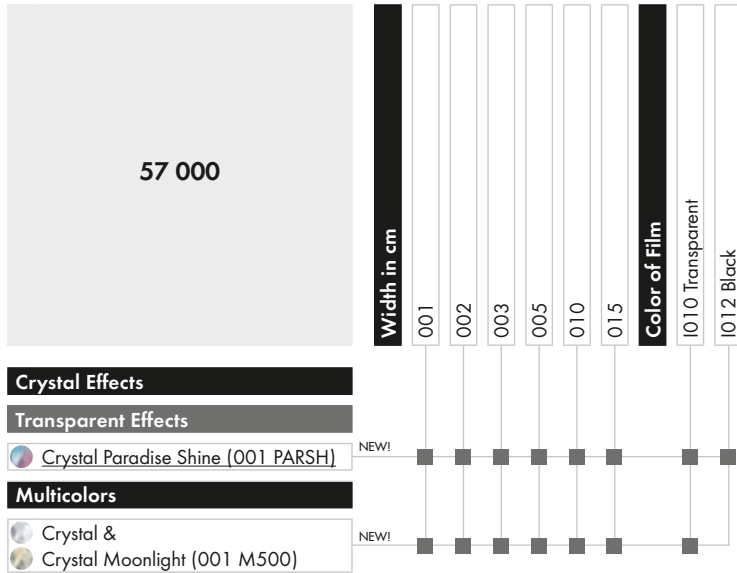

OVERVIEW OF AVAILABLE EFFECTS

Crystal Paradise Shine (001 PARSH)



010 Transparent

012 Black

Crystal & Crystal Moonlight (001 M500)





010 Transparent

NEW EFFECTS FOR CRYSTAL ROCKS MOTIFS

72 000
onwards

| Color of Film | IO10 Transparent | IO12 Black |
|------------------------------------|------------------|------------|
| Crystal | | |
| Crystal (001) | NEW! | ■ |
| Colors | | |
| Plain Colors | | |
| Erinite (360) | NEW! | ■ ■ |
| Light Siam (227) | NEW! | ■ ■ |
| Sunflower (292) | NEW! | ■ ■ |
| Tangerine (259) | NEW! | ■ ■ |
| Vintage Rose (319) | NEW! | ■ ■ |
| Crystal Effects | | |
| Transparent Effects | | |
| Crystal Paradise Shine (001 PARSH) | NEW! | ■ ■ |

OVERVIEW OF AVAILABLE COLORS & EFFECTS

| | | |
|---|--|---|
| <p>Crystal (001)</p>  <p style="text-align: center;">010 Transparent</p> | <p>Erinite (360)</p>  <p style="text-align: center;">010 Transparent 012 Black</p> | <p>Light Siam (227)</p>  <p style="text-align: center;">010 Transparent 012 Black</p> |
|---|--|---|

Sunflower (292)



010 Transparent

012 Black

Tangerine (259)



010 Transparent

012 Black

Vintage Rose (319)



010 Transparent

012 Black

Crystal Paradise Shine (001 PARSH)



010 Transparent

012 Black

NEW EFFECTS FOR CRYSTAL FINE ROCKS MOTIFS

74 000 onwards

Color of Film

IO10 Transparent IO12 Black

Crystal

Crystal (001) NEW!

Colors

Plain Colors

Erinite (360) NEW!

Light Siam (227) NEW!

Sunflower (292) NEW!

Tangerine (259) NEW!

Vintage Rose (319) NEW!

Crystal Effects

Transparent Effects

Crystal Paradise Shine (001 PARSH) NEW!

OVERVIEW OF AVAILABLE COLORS & EFFECTS

Crystal (001)



010 Transparent

Erinite (360)



010 Transparent

012 Black

Light Siam (227)



010 Transparent

012 Black

Self-adhesive Elements

Crystal Fine Rocks-it

Sunflower (292)



010 Transparent

012 Black

Tangerine (259)



010 Transparent

012 Black

Vintage Rose (319)



010 Transparent

012 Black

Crystal Paradise Shine (001 PARSH)



010 Transparent

012 Black

Transfers

Transfers are ideal for Hotfix application on all kinds of textiles. They are available in a large range of motifs from the in-house design team, but also offer customizing possibilities with different articles from the Flat Back Hotfix assortment.

New Exclusive Colors for art. 2038 XILION Rose and art. 2078 XIRIUS Rose

Crystal Scarabaeus Green (001 SCGR)

New Exclusive Colors for Diamonds

Crystal Scarabaeus Green (001 SCGR)

Crystal Light Chrome (001 LTCH)

Available in the following sizes:

2038 XILION Rose

SS 6, SS 8, SS 10

2078 XIRIUS Rose

SS 12, SS 16, SS 20, SS 34

1360 (with art. 1028 XILION Chaton)

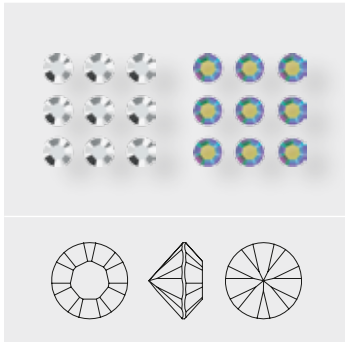

1360 (with art. 1088 XIRIUS Chaton)

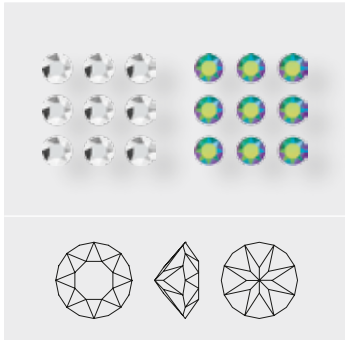

1360

Size

PP 7 (PP7 with art. 1028 XILION Chaton)

PP 12 (PP12 with art. 1028 XILION Chaton)

PP 17 (PP17 with art. 1088 XIRIUS Chaton)

Crystal Effects

Metallic Effects

Crystal Light Chrome (001 LTCH)

NEW!

Crystal Scarabaeus Green (001 SCGR)

NEW!

Transfers

2078/G XIRIUS Rose partly frosted ^{NEW!}

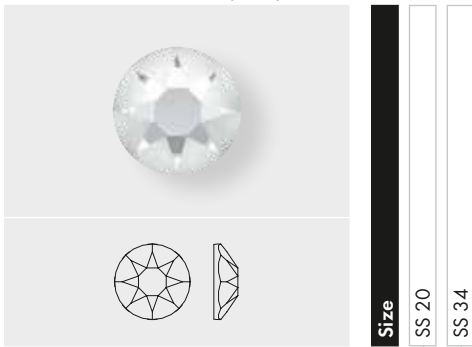

| | | |
|---------------------|---|---|
| Crystal | | |
| Crystal A HF (001) | ■ | ■ |
| Colors | | |
| Plain Colors | | |
| Jet A HF (280) | ■ | ■ |

Size
SS 20
SS 34

2080/4 Cabochon

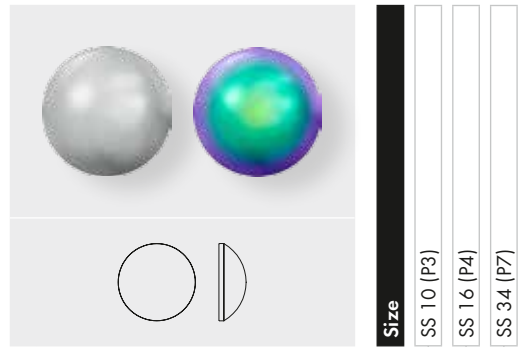

| | | | |
|--|---|---|---|
| Crystal Effects | | | |
| Metallic Effects | | | |
| Crystal Light Chrome HF (001 LTCH) | ■ | ■ | ■ |
| Crystal Scarabaeus Green HF (001 SCGR) | ■ | ■ | ■ |

Size
SS 10 (P3)
SS 16 (P4)
SS 34 (P7)

2300 Drop Flat Back

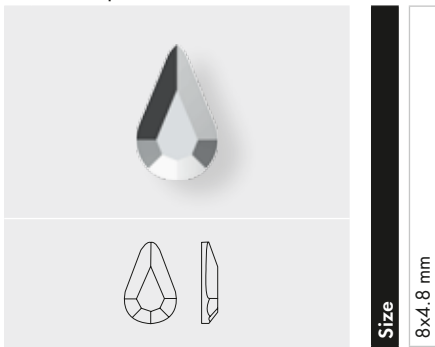

| | |
|--|---|
| Crystal Effects | |
| Metallic Effects | |
| Crystal Light Chrome M HF (001 LTCH) ^{NEW!} | ■ |

Size
8x4.8 mm

2304 Raindrop Flat Back ^{NEW!}

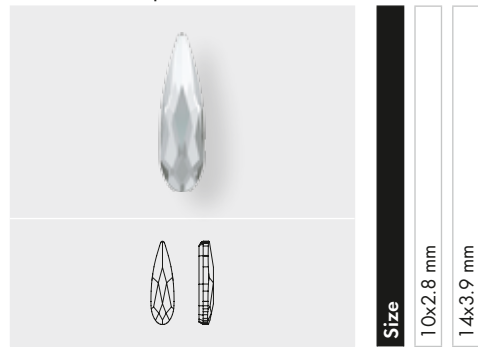

| | | |
|-------------------------------------|---|---|
| Crystal | | |
| Crystal F (001) | ■ | ■ |
| Colors | | |
| Plain Colors | | |
| Blush Rose F (257) | ■ | ■ |
| Jet (280) | ■ | ■ |
| Light Siam F (227) | ■ | ■ |
| Crystal Effects | | |
| Transparent Effects | | |
| Crystal AB F (001 AB) | ■ | ■ |
| Crystal Blue Shade F (001 BLSH) | ■ | ■ |
| Crystal Golden Shadow F (001 GSHA) | ■ | ■ |
| Crystal Luminous Green F (001 LUMG) | ■ | ■ |
| Crystal Silver Night (001 SINI) | ■ | ■ |

Size
10x2.8 mm
14x3.9 mm

Transfers

2400 Square Flat Back

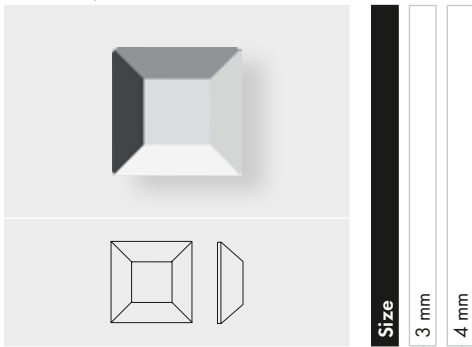

Size
3 mm
4 mm

Crystal Effects

Metallic Effects

● Crystal Light Chrome M HF (001 LTCH)

NEW!

2510 Baguette Flat Back

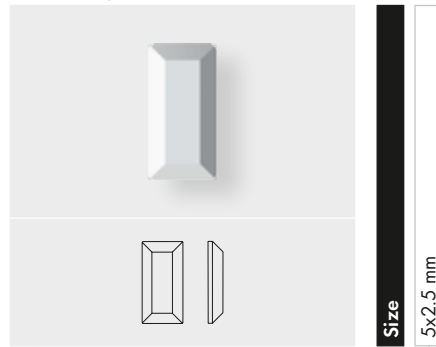

Size
5x2.5 mm

Crystal Effects

Metallic Effects

● Crystal Light Chrome M HF (001 LTCH)

NEW!

2714 Fan Flat Back

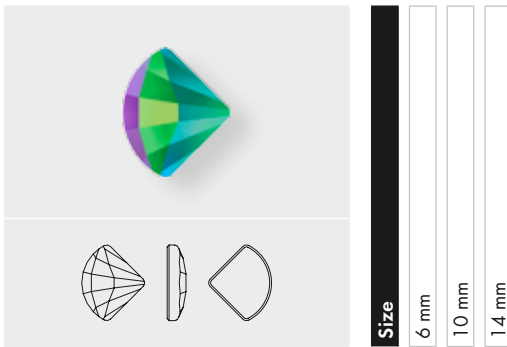

Size
6 mm
10 mm
14 mm

Crystal Effects

Metallic Effects

● Crystal Scarabaeus Green M HF (001 SCGR)

NEW!

2813 Moon Flat Back

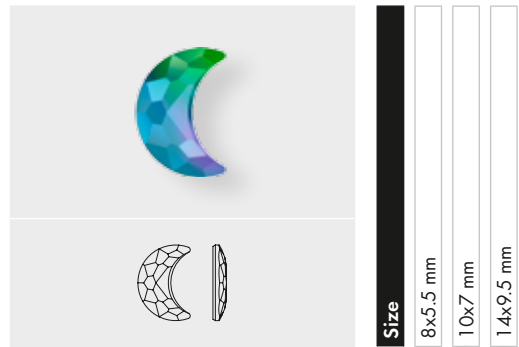

Size
8x5.5 mm
10x7 mm
14x9.5 mm

Crystal Effects

Metallic Effects















● Crystal Scarabaeus Green M HF (001 SCGR)

NEW!

Transfers

Swarovski Metallics for Transfers are now available in six new appealing colors. Highly sought after by all markets, these colors beautifully complement the existing crystal assortment and lay the foundation for versatile new looks and design possibilities.







METALLICS

| | | | | | |
|---|-----------------------------|---|-----------------------------|---|-----------------------------|
|  | 3490 3490/006 (M2*) |  | 3490 3490/008 (M8) |  | 3490 3490/002 (M10x3) |
|  | 3490 3490/012 (M2.5*) |  | 3490 3490/009 (M28*) |  | 3490 3490/010 (M7x3*) |
|  | 3490 3490/300 (M3*) |  | 3490 3490/007 (M10) |  | 3490 3490/003 (MST) |
|  | 3490 3490/400 (M4*) |  | 3490 3490/001 (M7x7) |  | 3490 3490/005 (M12x6) |
|  | 3490 3490/600 (M6) |  | 3490 3490/011 (M3x3*) |  | 3490 3490/013 (M9x4) |

NEW COLORS

| | | | | | |
|---|---------------------------|---|--------------------------|---|-------------------------|
|  | Signal White (R 9003*) |  | Traffic Red (R 3020*) |  | Azure Blue (R 5009*) |
|  | Grey Beige (R 1019*) |  | Blue Lilac (R 4005*) |  | Jet Black (R 9005*) |

CARE INSTRUCTIONS

|  |  |  |  |  |  |
|---|---|---|---|---|---|
| Turn inside out, choose a gentle wash cycle and use mild laundry detergent. | Do not use chlorine bleach! | Do not tumble dry! | Iron inside out using a silk/ polyester/ viscose setting. | The textile can be gently dry-cleaned using hydrocarbon. Turn inside out. | The textile will withstand gentle professional wet cleaning. Turn inside out. |
| To protect the crystals as much as possible, the use of a soft wash bag is recommended. | | | Please be advised that ironing too long may reactivate the adhesive. It is recommended to turn the textile inside out and use a pressing cloth. | | |

* Color tones according to the RAL colors.



13 199 04



| | |
|---|-----------------------|
| C | 280HEM/001SCGR |
| E | CS5X2/S6 |
| S | ~982x11 (123 SEG/ROW) |
| M | 9 ROWS |
| | 100% |

13 200 04

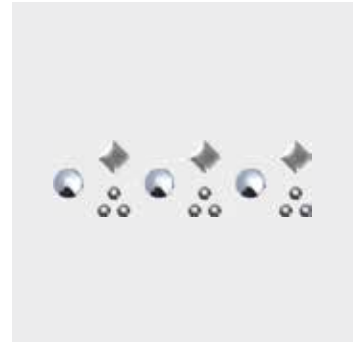

| | |
|---|----------------------|
| C | 000-000/280HEM |
| E | M3X3-P4/S5 |
| S | ~982x10 (82 SEG/ROW) |
| M | 11 ROWS |
| | 100% |

13 201 04

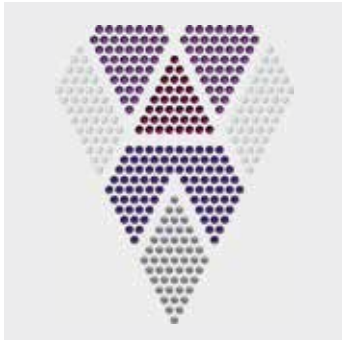

| | |
|---|---------------------|
| C | 092/086-277/204/515 |
| E | M2/M2-S6/S6/S6 |
| S | ~57x72 |
| M | 39 PCS |
| | 55% |

13 202 04



| | |
|---|--|
| C | 000-001CHRMV/000/280HEM/ 280HEM/001SCGR/280AB/000 |
| E | M2-P3/P4/P4/CS5X2/S6/S10/S16 |
| S | ~110x148 |
| M | 12 PCS |
| | 28% |

13 203 04

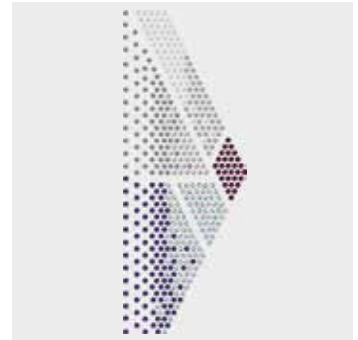

| | |
|---|---------------------------------|
| C | 086/092/082/096-001SCGR/277/515 |
| E | M2/M2/M2/M2-S6/S6/S6 |
| S | ~47x122 |
| M | 28 PCS |
| | 35% |

13 204 04



| | |
|---|--|
| C | 000/082-001CHRMV/001PBLUHFT/ 001CHRMV/001LTCH/001SCGR |
| E | M2/M2-P3/P4/P4/S10/S10 |
| S | ~82x83 |
| M | 22 PCS |
| | 48% |

13 205 04



| | |
|---|-------------------------------|
| C | 082-277/001SCGR/280AB/001LUMG |
| E | M2-S6/S6/S6/S6 |
| S | ~191x23 |
| M | 29 PCS |
| | 22% |

13 206 04



| | |
|---|--------------------|
| C | 000/001SSHA/280HEM |
| E | CS3X3/S3/S3 |
| S | ~19x20 |
| M | 220 PCS |
| | 100% |

13 207 04



| | |
|---|-------------------|
| C | 096-280AB/001SCGR |
| E | M2-S6/S6 |
| S | ~22x22 |
| M | 210 PCS |
| | 100% |

13 208 04



| | |
|---|---------------------|
| C | 070-001LTCH/001SSHA |
| E | M2-S6/S6 |
| S | ~16x31 |
| M | 234 PCS |
| | 100% |

13 209 04



| | |
|---|-----------------------|
| C | 096/071-001LTCH/280AB |
| E | M2/M2-S6/S6 |
| S | ~33x47 |
| M | 96 PCS |
| | 80% |

13 210 04



| | |
|---|-------------|
| C | 001SCGR/277 |
| E | S6/S6 |
| S | ~39x39 |
| M | 80 PCS 100% |

13 211 04



| | |
|---|-------------------------|
| C | 280HEM/001CHRMV/001ITCH |
| E | P4/P4/S10 |
| S | ~45x46 |
| M | 68 PCS 80% |



13 177 06

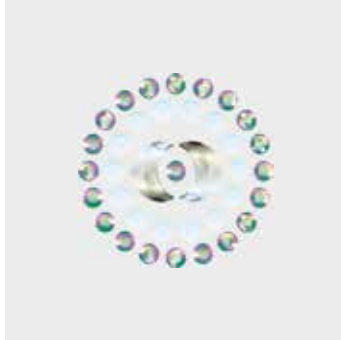

| | |
|---|---------------------------|
| C | 001PBLUHFT/001MOL/001SCGR |
| E | P3/2813MM8X5,5/S10 |
| S | ~26x26 |
| M | 78 PCS 100% |

13 178 06



| | |
|---|----------------------------|
| C | 001PBLUHFT/001/001/001SCGR |
| E | P3/CS4X4/2037MM14/S10 |
| S | ~32x32 |
| M | 50 PCS 100% |

13 179 06



| | |
|---|----------------|
| C | 001PBLUHFT/001 |
| E | P7/CS7X6 |
| S | ~46x17 |
| M | 48 PCS 80% |

13 180 06

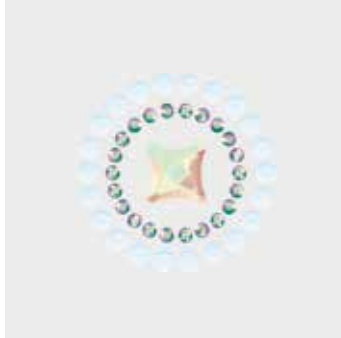

| | |
|---|--------------------------|
| C | 001PBLUHFT/001AB/001SCGR |
| E | P3/2494MM8/S6 |
| S | ~26x26 |
| M | 60 PCS 100% |

13 181 06



| | |
|---|--------------------------|
| C | 092-001SSHA/001/001METBL |
| E | M8-S3/S5/S10 |
| S | ~16x16 |
| M | 144 PCS 100% |

13 182 06



| | |
|---|----------------------------------|
| C | 001PBLUHFT/001PBLUHFT/001PBLUHFT |
| E | P3/P4/2858MM6X4,5 |
| S | ~15x16 |
| M | 105 PCS 100% |

13 183 06



| | |
|---|--------------------------|
| C | 092-001/001SCGR/001METBL |
| E | M8-S6/S10/S10 |
| S | ~19x19 |
| M | 112 PCS 100% |

13 184 06



| | |
|---|--------------|
| C | 280HEM |
| E | CS8X4 |
| S | ~14x16 |
| M | 264 PCS 100% |

13 185 06

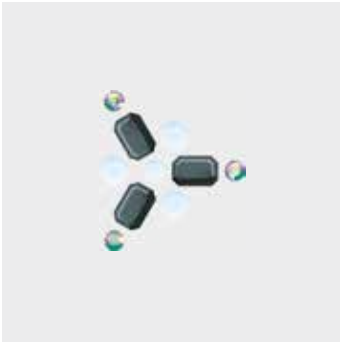

C 001PBLUHFT/001PBLUHFT/
280HEM/001SCGR
E P3/P4/CS6X4/S10
S ~19x21
M 105 PCS 100%

13 186 06

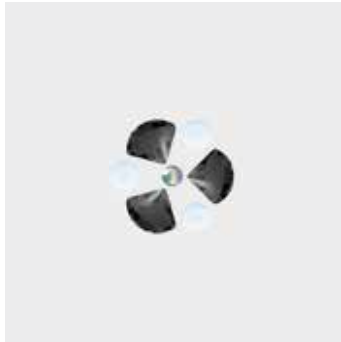

C 001PBLUHFT/001SINI/001SCGR
E P4/2714MM60/S10
S ~16x15
M 119 PCS 100%

13 187 06



C 001PBLUHFT/001PBLUHFT/
001/001SCGR
E P3/P4/2813MM8X5,5/S16
S ~19x17
M 112 PCS 100%

13 188 06



C 001PBLUHFT/001/001SCGR
E P3/2494MM6/S10
S ~19x18
M 112 PCS 100%

13 189 06



C 001PBLUHFT/001/001SCGR/001SCGR
E P4/2858MM6X4,5/S10/S16
S ~19x18
M 105 PCS 100%

13 190 06



C 001SCGR/001LTCH/001SSHA/
001/001SCGR
E S6/S8/S10/S30/S34
S ~952x7 [8 SEG/ROW]
M 8 ROWS

13 191 06



C 092/082-001GSHA
E M3X3/M3X3-CS3X3
S ~76x20
M 77 PCS 50%

13 192 06



C 001PBLUHFT/001/001SCGR
E P3/S3/S8
S ~492x3 [22 SEG/ROW]
M 13 ROWS 90%

13 193 06



C 091/081-001AB
E M7X3/M12X6-CS5X2,5
S ~135x85
M 12 PCS 30%

13 194 06



C 070/070-001AB
E M12X6/M12X6-CS7X6
S ~161x98
M 10 PCS 25%

13 195 06



C 091/091/091-001GSHA/
001METSH/001METSH
E M3X3/M10X3/M7X3-CS3X3/S8/S10
S ~150x64
M 18 PCS 25%

13 196 06



C 092/082-001
E M12X6/M12X6-CS7X6
S ~137x94
M 14 PCS 30%

13 197

06



| | |
|----------|------------------|
| C | 092-001/001METBL |
| E | M8-2037MM14/S10 |
| S | ~68x19 |
| M | 36 PCS |
| | 60% |

13 198

06



| | |
|----------|------------|
| C | 001 |
| E | S20G |
| S | ~44x14 |
| M | 56 PCS |
| | 90% |

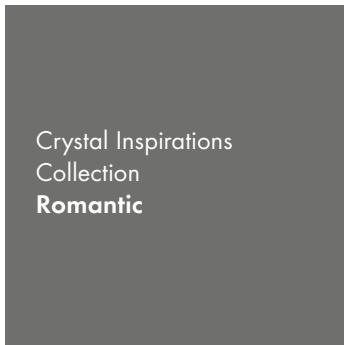

13 149

08



| | |
|----------|--------------------------------------|
| C | 084/094-001/001BLAPA/220/257 |
| E | M12X6/M12X6-CS7X6/ 2493MM8/S8/S10 |
| S | ~71x36 |
| M | 44 PCS |
| | 60% |

13 150

08



| | |
|----------|---------------------------------------|
| C | 084/084-001CHRMV/280HEM/257/653 |
| E | M8/M12X6-P3/CS7X6/ 2813MM8X5,5/S10 |
| S | ~79x60 |
| M | 33 PCS |
| | 50% |

13 151

08



| | |
|----------|----------------------|
| C | 094-001/257/228/257 |
| E | M3X3-CS4X4/S8/S8/S12 |
| S | ~63x37 |
| M | 60 PCS |
| | 65% |

13 152

08



| | |
|----------|-----------------------------|
| C | 084-001MIGLD/001DOR/001GSHA |
| E | M2-S6/S6/S6 |
| S | ~87x44 |
| M | 40 PCS |
| | 50% |

13 153

08



| | |
|----------|-----------------|
| C | 094-257/220/228 |
| E | M12X6-S6/S8/S8 |
| S | ~52x41 |
| M | 64 PCS |
| | 65% |

13 154 08



| | | |
|---|-------------------|-----|
| C | 094-001GSHA | |
| E | M10X3-2555MM8X2,6 | |
| S | ~51x23 | |
| M | 75 PCS | 75% |

13 155 08

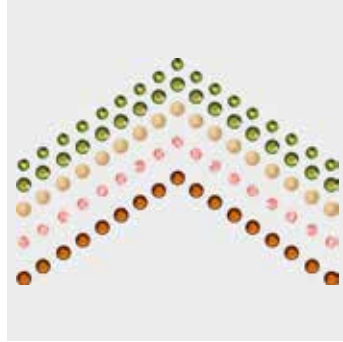

| | | |
|---|------------------------|-----|
| C | 094-228/257/001TAB/220 | |
| E | M2,5-S6/S6/S8/S8 | |
| S | ~53x37 | |
| M | 60 PCS | 80% |

13 156 08



| | | |
|---|-----------------------------|-----|
| C | 084-001GSHA/001/228/653/257 | |
| E | M12X6-CS3X3/CS7X6/S8/S8/S10 | |
| S | ~166x72 | |
| M | 20 PCS | 25% |

13 157 08

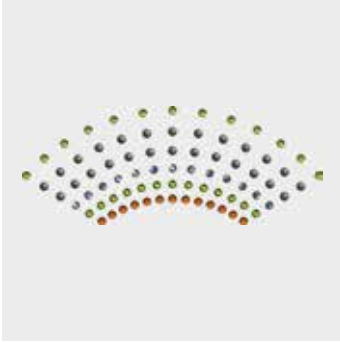

| | | |
|---|----------------------------|-----|
| C | 001-617/220/001TAB/653/228 | |
| E | P3/S10/S10/S10/S10 | |
| S | ~99x39 | |
| M | 38 PCS | 40% |

13 158 08



| | | |
|---|---|-----|
| C | 094/084-001/220/653/ 001HFT/220/220SAT | |
| E | M2/M2,5-P3/CS5X2,5/S6/S8/S8/S8/S8 | |
| S | ~181x98 | |
| M | 10 PCS | 24% |

13 159 08



| | | |
|---|-------------------|-----|
| C | 001HFT/284/001TAB | |
| E | S6/S6/S6 | |
| S | ~76x105 | |
| M | 24 PCS | 40% |

13 160 08



| | | |
|---|---------------------------------------|-----|
| C | 084-001TAB/653/220/ 001PGREHFT/228 | |
| E | M2,5-S10/S10/S10/S10/S10 | |
| S | ~200x69 | |
| M | 14 PCS | 20% |

13 176 09



| | | |
|---|---|-----|
| C | 086/096/084/094/096/ 084-001/001BLAPA/228 | |
| E | M7X7/M7X7/M7X7/M7X7/M3X3/ M3X3-CS3X3/2493MM12/S8 | |
| S | ~245x206 | |
| M | 3 PCS | 16% |



13 161 10

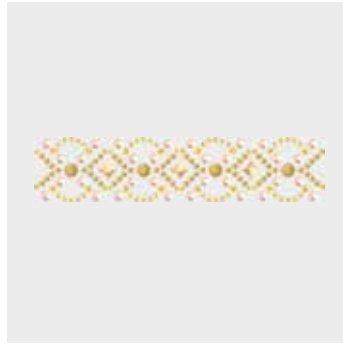

| | |
|----------|---|
| C | 091/091-001GSHA/001GSHA/ 001METSH/001METSH |
| E | M2,5/M6P4/2494MM6/S6/S10 |
| S | ~128x28 |
| M | 35 PCS 30% |

13 162 10



| | |
|----------|--|
| C | 091-001GSHA/001GSHA/ 001METSH/001MOL |
| E | M2,5-P4/2494MM6/S6/S34 |
| S | ~40x28 |
| M | 96 PCS 100% |

13 163 10

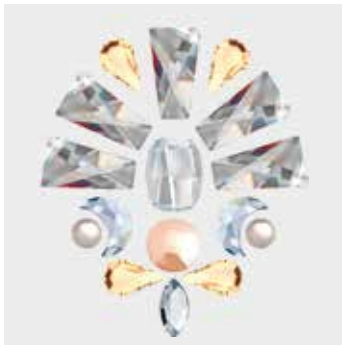

| | |
|----------|---|
| C | 001621/001GSHA/001GSHA/ 001/001/001/001 |
| E | P4/P7/CS8X5/CS8X4/2770MM120X70/ 2585MM10/2813MM8X5,5 |
| S | ~35x41 |
| M | 36 PCS 100% |

13 164 10

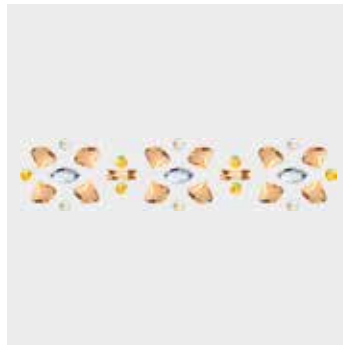

| | |
|----------|---|
| C | 001291/001/001GSHA/ 001GSHA/001METSH |
| E | P3/CS8X4/2555MM8X2,6/ 2714MM60/S12 |
| S | ~84x19 |
| M | 30 PCS 50% |

13 165 10

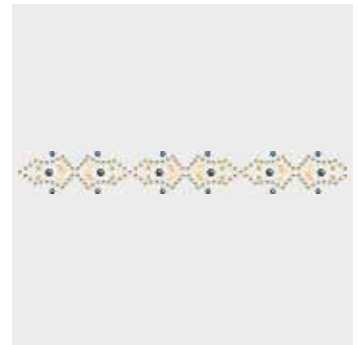

| | |
|----------|---|
| C | 091-001617/001GSHA/ 001GSHA/001METBL |
| E | M2,5-P4/2813MM8X5,5/S6/S10 |
| S | ~929x22 (16 SEG/ROW) |
| M | 6 ROWS 25% |

13 166 10

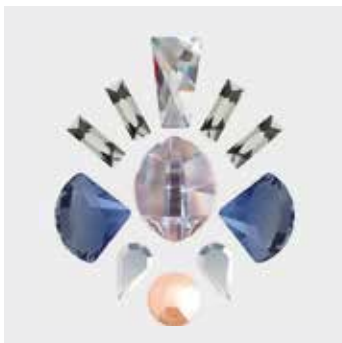

| | |
|----------|--|
| C | 001GSHA/001/001SSHA/ 001/001/001BLSH |
| E | P7/CS8X5/2555MM8X2,6/2770MM120X70/ 2204MM14/2714MM100 |
| S | ~32x38 |
| M | 40 PCS 100% |

13 167 10



| | |
|----------|--|
| C | 280HEM/001CHRMV/215/ 001/001SINI/227/001 |
| E | P4/P7/2770MM60X35/2770MM120X70/ 2714MM60/2714MM140/2813MM14X9,5 |
| S | ~37x40 |
| M | 36 PCS 100% |

13 168 10

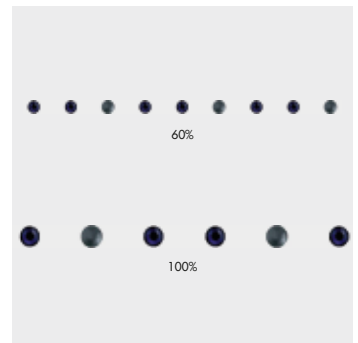

| | |
|----------|---------------------|
| C | 280HEM/288 |
| E | P3/S10 |
| S | ~978x3 (39 SEG/ROW) |
| M | 13 ROWS |

13 169 10



C 001GSHA/001/001/001/001GSHA
 E P3/CS6X4/CS8X5/CS5X2/2813MM8X5,5
 S ~85x21
 M 60 PCS 50%

13 170 10



C 091/091/091-001291/001GSHA/
 001GSHA/001GSHA/001/001GSHA
 E M3/M6/M12X6-P4/P7/CS8X5/
 CS8X4/2813MM10X7/S20
 S ~72x61
 M 18 PCS 60%

13 171 10



C 091-001GSHA
 E M2,5-S12
 S ~969x3 (58 SEG/ROW)
 M 14 ROWS 95%

13 172 10



C 001GSHA/001/001/001/001GSHA
 E P3/CS6X4/CS8X5/CS5X2/2813MM8X5,5
 S ~32x21
 M 162 PCS 80%

13 173 10



C 081/091-001METSH
 E M2,5/M8-P3/S6
 S ~22x32
 M 198 PCS 100%

13 174 10

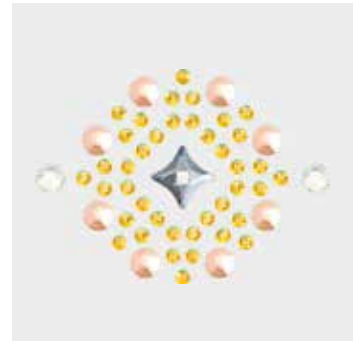

C 001GSHA/001/001METSH/001MOL
 E P4/2494MM6/S6/S16
 S ~39x28
 M 120 PCS 100%

13 175 10



C 091-001GSHA/001GSHA/001MOL/
 234/001MOL
 E M12X6-P3/CS8X4/2813MM8X5,5/
 2753MM10/S10
 S ~32x34
 M 110 PCS 100%

Synthetics Hotfix such as Crystal Rocks and Crystal Fine Rocks, Crystal Fabric, and Crystaltex combine elegant crystals from Swarovski with synthetic carrier materials that can be applied using Hotfix technology. They are ideal for use in the textile, interior design, jewelry, and accessories segments.

GRAPHIC FABRIC, FINE ROCKS & ROCKS

Taking the word “image” from “imagination” and leading it to new creative heights, Swarovski presents a new graphic technology that opens up a world of design possibilities – in an unprecedented richness of detail!

The new product group Graphic allows for the printing of individual motifs – such as pictures, graphics, logos or letterings – onto the customer favorites Crystal Fabric, Crystal Rocks and Crystal Fine Rocks.

The two different printing methods, either on or below the crystal, or a combination of both enrich your personal motif with a sparkling 3D surface for stunning effects in a series of application fields.

As a true highlight and stunning innovation in our assortment, the Graphic Fabric, Fine Rocks & Rocks speak to the rising demand for personalized design items. It highlights our desire for an individual look in a world of mass production.

GRAPHIC OFFERS DIFFERENT PRINTING METHODS:



Foil Print (FP)

The motif is being printed on the foil below the crystal, which means...

- The brilliance of the crystal remains
- Blurred contours can be used as a design element, e.g. for mille fleurs motifs



Glass Print (GP)

The motif is being printed on crystal, which means...

- Highly precise reproduction of the motif, even of tiny details and small fonts
- No blurring occurs
- Matte effect can be used as a design element

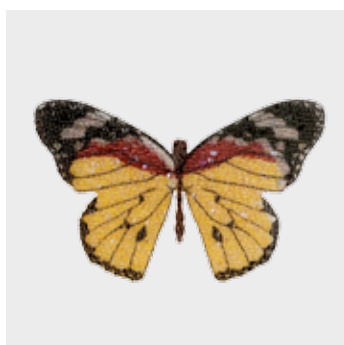

Combination of Foil & Glass Print (FP&GP)

- Spectacular depth effects
- Highlighting special features of the design

ARTICLE EXPLANATION

Graphic Fabric

57 354



C 022-FP10033 GP10092 001 M500
 S ~86x100
 M 30 PCS

Graphic Fine Rocks

74 031



C 022-FP10057 001
 S ~30x30
 M 80 PCS

Graphic Rocks

72 034



C 022-GOP10104 001
 S ~85x85
 M 12 PCS

57 354
 74 031
 72 034

| | C | S | M |
|----------------|---------------------------------|------------------|--|
| Article number | Color assortment | Motif size in mm | Minimum order quantity in pieces (PCS) |
| | FP Foil print GP Glass print | | |

ORDERING EXAMPLE & PRODUCT VARIETY EXPLANATION

| 57 354 | FP10033 GP10092 | 022 | 001M500 |
|----------------|---|---|------------------------------------|
| Article number | Print technique | Color of film | Color of crystals |
| | FP Foil Print GP Glass Print FP & GP Foil Print & Glass Print | Hotfix version: 022 White 012 Black 010 Transparent It version: I022 White I012 Black I010 Transparent | Please see respective color matrix |

OVERVIEW OF ALL AVAILABLE COLORS AND EFFECTS

Graphic Fabric

| | | | | | | | |
|---|---|-----------------|-----------|-----------|--------------|----------------|----------------|
| <p>57 000 onwards</p> | Color of Film | 010 Transparent | 012 Black | 022 White | Print | Print on foil* | Print on glass |
| | Crystal Effects | | | | | | |
| | Transparent Effects | | | | | | |
| | Crystal AB (001 AB) | ■ | ■ | ■ | ■ | ■ | ■ |
| | Crystal Golden Shadow (001 GSHA) | ■ | | ■ | ■ | ■ | ■ |
| | Metallic Effects | | | | | | |
| | Crystal Comet Argent Light (001 CAL) | ■ | | | | ■ | |
| | Crystal Metallic Light Gold (001 MLGLD) | ■ | | | | | ■ |
| | Crystal Effects | | | | | | |
| | Transparent Effects | | | | | | |
| Jet Hematite (280 HEM) | | | ■ | | | ■ | |
| Multicolors | | | | | | | |
| Crystal & Crystal Moonlight (001 M500) | ■ | | ■ | | ■ | ■ | |

* Print on foil will not be visible when using the covering crystal colors/effects.
 Only if print on foil is possible will a combination of both (print on foil & print on glass) be offered.

OVERVIEW OF ALL AVAILABLE COLORS AND EFFECTS

Graphic Fine Rocks and Graphic Rocks

| 74 000 & 72 000 onwards | | Color of Film | 010 Transparent | 012 Black | 022 White | Print | Print on foil* | Print on glass |
|---|--|---------------|-----------------|-----------|-----------|-------|----------------|----------------|
| Colors | | | | | | | | |
| Plain Colors | | | | | | | | |
| Crystal (001) | | | ■ | | ■ | | ■ | ■ |
| Jet (280) | | | | ■ | | | | ■ |
| Opal Colors | | | | | | | | |
| White Alabaster (281) | | | ■ | | | | | ■ |
| Crystal Effects | | | | | | | | |
| Transparent Effects | | | | | | | | |
| Crystal AB (001 AB) | | | ■ | ■ | ■ | | ■ | ■ |
| Crystal Bermuda Blue (001 BBL) | | | | ■ | | | | ■ |
| Crystal Golden Shadow (001 GSHA) | | | ■ | | ■ | | ■ | ■ |
| Crystal Moonlight (001 MOL) | | | ■ | ■ | ■ | | ■ | ■ |
| Crystal Silver Shade (001 SSHA) | | | ■ | ■ | ■ | | ■ | ■ |
| Metallic Effects | | | | | | | | |
| Crystal Comet Argent Light (001 CAL) | | | ■ | | | | | ■ |
| Crystal Metallic Light Gold (001 MLGLD) | | | ■ | | | | | ■ |
| Crystal Metallic Silver (001 METSI) | | | | ■ | | | | ■ |

* Print on foil will not be visible when using the covering crystal colors/effects.
 Only if print on foil is possible will a combination of both (print on foil & print on glass) be offered.

Standard Collection
Graphic Fabric
 57 000 onwards

57 354



| | |
|----------|-----------------------------|
| C | 022-FP10033 GP10092 001M500 |
| S | ~86x100 |
| M | 30 PCS |

57 356



| | |
|----------|-----------------------------|
| C | 022-FP10109 GP10110 001M500 |
| S | ~41x25 |
| M | 162 PCS |

57 358



| | |
|----------|---------------------|
| C | 022-FP10100 001M500 |
| S | ~71x71 |
| M | 48 PCS |

57 359



| | |
|----------|-----------------------------|
| C | 022-FP10111 GP10112 001M500 |
| S | ~115x43 |
| M | 42 PCS |

Standard Collection
Graphic Fine Rocks
 74 000 onwards

74 029*



| | |
|----------|-------------------------|
| C | 022-FP10090 GP10091 001 |
| S | ~100x100 |
| M | 9 PCS |

74 031

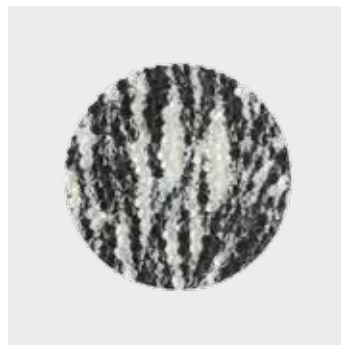

| | |
|----------|-----------------|
| C | 022-FP10057 001 |
| S | ~30x30 |
| M | 80 PCS |

74 032

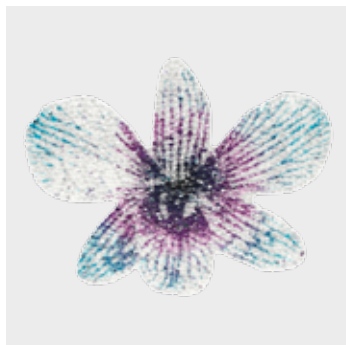

| | |
|----------|-----------------|
| C | 022-GP10104 001 |
| S | ~89x69 |
| M | 16 PCS |

* Picture only available as Graphic Fabric version

Standard Collection
Graphic Rocks
72 000 onwards

72 034



C 022-FP10073 GP10074 001
S ~85x85
M 12 PCS

72 035



C 022-GP10104 001
S ~89x69
M 16 PCS

SPECIAL MOTIF SERVICE

A special motif is a design created by the customer which is different from the Graphic Fabric, Fine Rocks & Rocks Standard Collection. This service opens up many customization possibilities and enables you to benefit from Swarovski's longstanding experience and design expertise. A range of customization options for existing motifs is available (see "Customization Possibilities" below).

You may also submit sketches of a design to suit your personal requirements – such as a brand image or an image that complements a particular sales campaign. This will then be made up according to your specifications using Computer Aided Design, which allows for easy adjustments tailored to your needs.

Required information for Graphic Fabric, Fine Rocks & Rocks

| | |
|--------------------------------------|----------------------------------|
| data format contour/outline | vector graphics (.dxf, .ai) |
| data format picture | raster graphic (.png) |
| picture resolution & size | min. 300dpi (full-scale picture) |
| colors | rgb |
| fonts | convert into paths |
| embedded pixel pictures | vector graphics required |

Due to the different print methods (foil or glas print) the colors will vary.

If detailed information and possible print tolerances (offset, color tolerance...) is needed, please contact Swarovski and an application request will be placed in our application database.

CUSTOMIZATION POSSIBILITIES FOR GRAPHIC FABRIC, FINE ROCKS & ROCKS

| | GRAPHIC FABRIC | GRAPHIC FINE ROCKS | GRAPHIC ROCKS |
|--|---|--|--|
| Max. motif size | 400x330 mm | 400x330 mm | 400x330 mm |
| Min. motif size | 10x10 mm (or effective surface of 1.0 cm ²) | 15x15 mm (or effective surface of 2.25 cm ²) | 15x15 mm (or effective surface of 2.25 cm ²) |
| Min. width of holes within motifs | 3 mm | 3 mm | 3 mm |
| Min. product surface | 3 mm | 4 mm | 9 mm |
| Min. size of the smallest element within a motif | 10x10 mm (or effective surface of 1.0cm ²) | 15x15 mm (or effective surface of 2.25 cm ²) | 15x15 mm (or effective surface of 2.25 cm ²) |

Due to production issues, motifs with edges and angles of less than 90° need to be rounded off.

ORDERING PROCESS

Send the request with a drawing you wish to order to your nearest Swarovski sales office. Make sure you include all measurements for the desired motif. Please also indicate which product group your special motif relates to (Graphic Fabric, Fine Rocks & Rocks).

You will then receive a quotation including your article number, minimum order quantity, price, and the line drawing of your special motif in PDF format. Please contact your Swarovski sales office again if any changes need to be made.

Your special motif will be produced and delivered following your confirmation.

IMPORTANT INFORMATION

Please always submit your drawing of the desired motif in the actual size you require. When enlarged to the desired size, a small sketch will have blurred lines that will make it difficult to correctly reinterpret. Full-scale pictures or drawings representing 100% size of the design or very good quality scans in JPG, BMP, or DXF format will ensure that we have clear data to work with. These can also be sent via e-mail or on a CD-ROM. If sending a sewing pattern, please include the whole pattern and not just cut outs. If the sketch is submitted as a hard copy by fax or e-mail, please include a scale legend (e.g. copy/scan with ruler next to the drawing). This will ensure that the desired size of the motif can be identified.

Due to the tolerance level of the crystals being applied onto carrier film, the final Graphic Fabric, Fine Rocks & Rocks motifs may slightly differ from the sketches or prints in relation to the motifs' outline. Therefore the product may be subject to individual variations with each reproduction. These variations are caused by technical production-related factors. As these variations are not deemed to be defects, warranty claims are excluded and Swarovski assumes no liability whatsoever in connection with them.

If detailed information on possible tolerances is needed (e.g. cavity production for a metal part) and print tolerances (offset, color tolerance...) please contact Swarovski and an application request will be placed in our application database.

If considered feasible, special productions are generally offered to all our customers. Please note: special productions are subject to acceptance by Swarovski and the order of a design does not automatically grant exclusive production of this design for the customer.







For detailed application information, please refer to the Application Manual and our business website SWAROVSKI.COM/PROFESSIONAL or contact your Swarovski sales office.

APPLICATION ADVICE

Graphic Fabric/ Fine Rocks/ Rocks can be easily applied using a standard heat press. The application parameters are the same as those that apply to Crystal Fabric/ Fine Rocks/ Rocks. For detailed information, please refer to the Application Manual and our business website SWAROVSKI.COM/PROFESSIONAL.

CARE INSTRUCTIONS

For detailed information, please refer to the Application Manual and our business website SWAROVSKI.COM/PROFESSIONAL.

|  |  |  |  |  |  |
|---|---|---|---|---|---|
| Turn inside out, choose a gentle wash cycle and use mild laundry detergent. | Do not use chlorine bleach! | Do not tumble dry! | Iron inside out using a silk/polyester/viscose setting. | The textile can be gently dry-cleaned using hydrocarbon. Turn inside out. | The textile will withstand gentle professional wet cleaning. Turn inside out. |
| To protect the crystals as much as possible, the use of a soft wash bag is recommended. | | | Ironing the textile inside out and using a pressing cloth is recommended. | | |

NEW EFFECTS FOR CRYSTAL FABRIC BANDINGS AND MOTIFS

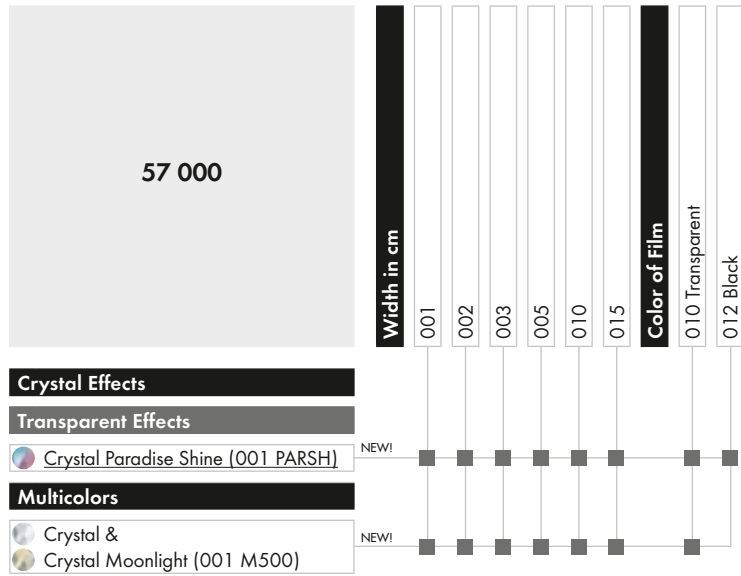

OVERVIEW OF AVAILABLE EFFECTS

Crystal Paradise Shine (001 PARSH)



010 Transparent

012 Black

Crystal & Crystal Moonlight (001 M500)



010 Transparent

NEW EFFECTS FOR CRYSTAL ROCKS MOTIFS

72 000
onwards

| Color of Film | 010 Transparent | 012 Black |
|------------------------------------|-----------------|-----------|
| Crystal | | |
| Crystal (001) | NEW! | ■ |
| Colors | | |
| Plain Colors | | |
| Erinite (360) | NEW! | ■ ■ |
| Light Siam (227) | NEW! | ■ ■ |
| Sunflower (292) | NEW! | ■ ■ |
| Tangerine (259) | NEW! | ■ ■ |
| Vintage Rose (319) | NEW! | ■ ■ |
| Crystal Effects | | |
| Transparent Effects | | |
| Crystal Paradise Shine (001 PARSH) | NEW! | ■ ■ |

OVERVIEW OF AVAILABLE COLORS & EFFECTS

Crystal (001)



010 Transparent 012 Black

Erinite (360)



010 Transparent 012 Black

Light Siam (227)



010 Transparent 012 Black

Synthetics Hotfix

Crystal Rocks

Sunflower (292)



010 Transparent

012 Black

Tangerine (259)



010 Transparent

012 Black

Vintage Rose (319)



010 Transparent

012 Black

NEW EFFECTS FOR CRYSTAL FINE ROCKS MOTIFS

74 000 onwards

Color of Film

010 Transparent 012 Black

Crystal

Crystal (001) NEW!

Colors

Plain Colors

Erinite (360) NEW!

Light Siam (227) NEW!

Sunflower (292) NEW!

Tangerine (259) NEW!

Vintage Rose (319) NEW!

Crystal Effects

Transparent Effects

Crystal Paradise Shine (001 PARSH) NEW!

OVERVIEW OF AVAILABLE COLORS & EFFECTS

Crystal (001)



010 Transparent

Erinite (360)



010 Transparent

012 Black

Light Siam (227)



010 Transparent

012 Black

Synthetics Hotfix

Crystal Fine Rocks

Sunflower (292)



010 Transparent 012 Black

Tangerine (259)



010 Transparent 012 Black

Vintage Rose (319)



010 Transparent 012 Black

Crystal Paradise Shine (001 PARSH)



010 Transparent 012 Black

Crystal Fine Rocks

Crystal Inspirations Collections



74 026

05



| | |
|----------|--|
| C | 010-001METS1 |
| S | ~44x14 |
| M | 98 PCS 80% |



74 027

06



| | |
|----------|--|
| C | 010-001AB |
| S | ~103x24 |
| M | 36 PCS 40% |

Crystal Buttons offer a huge assortment that includes Crystal Buttons, Buttons with Plastic Shanks, Decorative and Jeans Buttons, as well as Snap Fasteners in a variety of sizes, colors, and effects. With the crystals being integrated into the zipper teeth, zippers from our assortment make for glamorous attires.

3008 Classic Crystal Button (4 holes) ^{NEW!}

APPLICATION ADVICE

The Classic Crystal Button (4holes) can be applied by hand or using a domestic or industrial sewing machine. When sewing this button, synthetic multifilament threads with a thread count of Nm 80 are most suitable due to their abrasion resistance. Monofilament and pure cotton yarns are not recommended due to their limited abrasion resistance.

Please make sure that the transport system is deactivated to avoid any movement of the fabric. After selecting the over edge stitch, the length and width of the stitch must be adjusted to suit the element being applied. Due to the height of the article, using a program for sewing on buttons is not possible and it can only be applied without a standard presser foot.

CARE INSTRUCTIONS

The care instructions for the Classic Crystal Button (4holes) are the same as those that apply to the Crystal Button assortment. For detailed information, please refer to the Application Manual on our business website SWAROVSKI.COM/PROFESSIONAL.

PRODUCT DETAILS CRYSTAL ELEMENTS

| Article Size | Packing Unit = Minimum Order Quantity in Pieces | Average Net Weight in Gram per Packing Unit Crystal (001) | Average Gross Weight in Gram per Packing Unit Crystal (001) |
|--------------|---|---|---|
| 3008 | | | |
| 12 mm | 48 | 29.92 | 50.82 |
| 14 mm | 36 | 31.99 | 50.53 |
| 18 mm | 24 | 52.32 | 71.98 |

Buttons, Fasteners & Zippers

1791/120

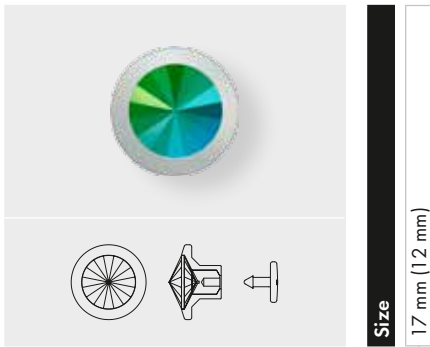

Size

17 mm (12 mm)

Color of Casing

081 Gold

082 Silver

086 Gun Metal

Crystal Effects

Metallic Effects

 Crystal Scarabaeus Green F (001 SCGR) NEW!

Crystal Buttons & Jeans Buttons

1792/100



Size

17 mm (10 mm)

Color of Casing

081 Gold

082 Silver

086 Gun Metal

Crystal Effects

Metallic Effects

 Crystal Light Chrome F (001 LTCH) NEW!

 Crystal Scarabaeus Green F (001 SCGR) NEW!

Buttons, Fasteners & Zippers

1810/S39

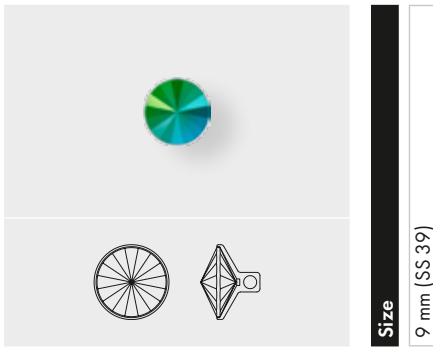

1810/S47

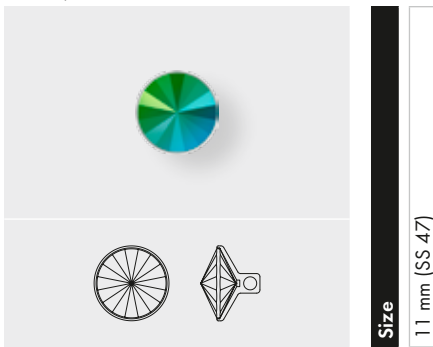

1810/120

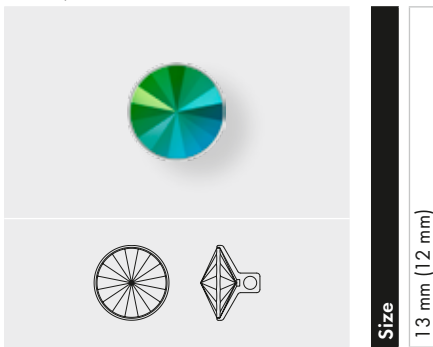

1810/140

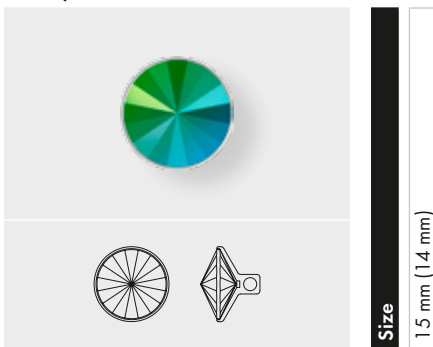

Buttons with Metal Shank

1810/S39
1810/S47
1810/120
1810/140

Crystal Effects

Metallic Effects

Crystal Scarabaeus Green F (001 SCGR) NEW!

Color of Casing

- 081 Gold
- 082 Silver
- 086 Gun Metal

Buttons, Fasteners & Zippers

1811/100

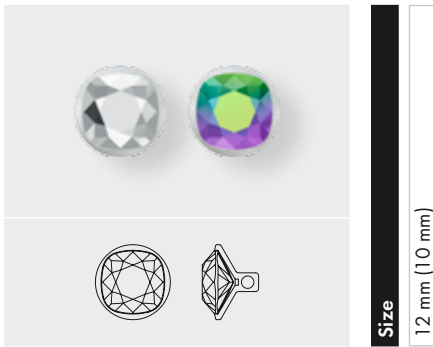

1811/120

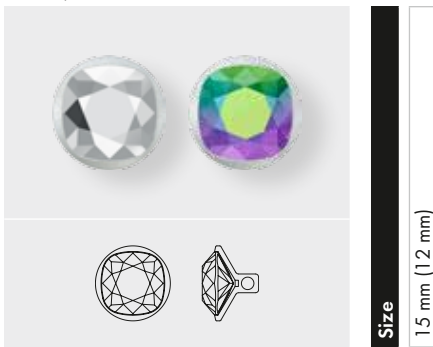

Buttons with Metal Shank

1811/100
1811/120

Color of Casing

- 081 Gold
- 082 Silver
- 086 Gun Metal

Crystal Effects

Metallic Effects

- Crystal Light Chrome F (001 LTCH) NEW!
- Crystal Scarabaeus Green F (001 SCGR) NEW!

Metal Trimmings are forward-integrated metal products and bestsellers among different segments. They can be sewn by hand or machine and mechanically applied onto different fabrics or other materials.

52 500



| | | |
|----|---------|------|
| R | 001-024 | |
| SS | PP 24 | |
| M | 05 M | 100% |

52 501 *

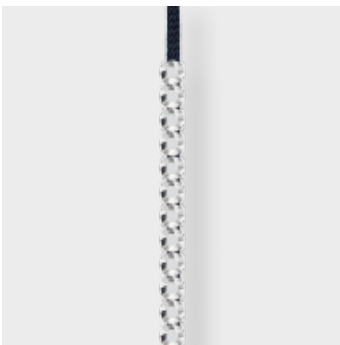

| | | |
|----|-------|------|
| R | 001 | |
| SS | PP 24 | |
| M | 10 M | 100% |

52 500
52 501 *

| | | | | | | | |
|---|-----------------------|-----------------------|------------------------|----------|------------|---------------|---------------|
| Color of Thread / Net-edge | 012 / 112 / 212 Black | 022 / 122 / 222 White | Color of Casing | 081 Gold | 082 Silver | 086 Gun Metal | 093 Rose Gold |
| Crystal Effects | | | | | | | |
| Metallic Effects | | | | | | | |
| Crystal Light Chrome F (001 LTCH) | NEW! | NEW! | NEW! | NEW! | NEW! | NEW! | NEW! |
| Crystal Scarabaeus Green F (001 SCGR) | NEW! | NEW! | NEW! | NEW! | NEW! | NEW! | NEW! |

* Art. 52 501 is not available with net-edge. When ordering one row with net-edge, art. 52 500 is to be used.

Metal Trimmings

55 000



R 001-024
 SS SS 20
 M 05 M 100%

55 001 *



R 001
 SS SS 20
 M 10 M 100%

55 300

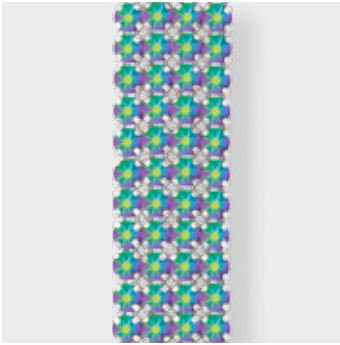

R 001-024
 SS SS 16
 M 05 M 100%

55 301 **



R 001
 SS SS 16
 M 05 M 100%

Flat Back Bandings

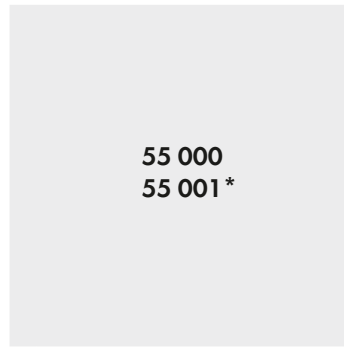

55 000
 55 001 *

Crystal Effects

Metallic Effects

- Crystal Light Chrome F (001 LTCH) NEW!
- Crystal Scarabaeus Green F (001 SCGR) NEW!

Color of Thread / Net-edge

- 012 / 112 / 212 Black
- 022 / 122 / 222 White

Color of Casing

- 081 Gold
- 082 Silver
- 086 Gun Metal
- 093 Rose Gold



55 300
 55 301 **

Crystal Effects

Metallic Effects

- Crystal Light Chrome F (001 LTCH) NEW!
- Crystal Scarabaeus Green F (001 SCGR) NEW!

Color of Thread / Net-edge

- 012 / 112 / 212 Black
- 022 / 122 / 222 White

Color of Casing

- 081 Gold
- 082 Silver
- 086 Gun Metal
- 093 Rose Gold

* Art. 55 001 is not available with net-edge. When ordering one row with net-edge, art. 55 000 is to be used.
 ** Art. 55 301 is not available with net-edge. When ordering one row with net-edge, art. 55 300 is to be used.

Metal Trimmings

55 500

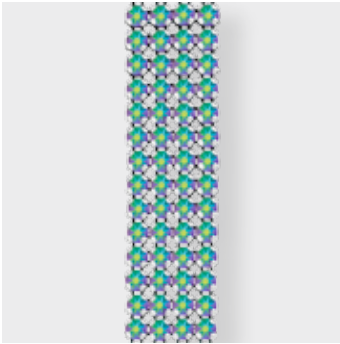

| | | |
|----|---------|------|
| R | 001-024 | |
| SS | SS 12 | |
| M | 10 M | 100% |

55 501 *

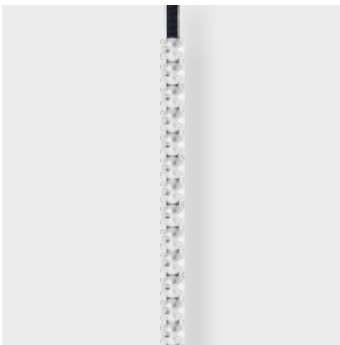

| | | |
|----|-------|------|
| R | 001 | |
| SS | SS 12 | |
| M | 10 M | 100% |

Flat Back Bandings

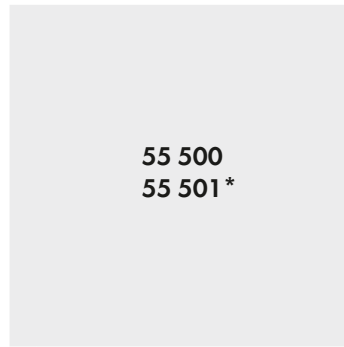

Crystal Effects

Metallic Effects

| | | | | | | | |
|---------------------------------------|------|---|---|---|---|---|---|
| Crystal Light Chrome F (001 LTCH) | NEW! | ■ | ■ | ■ | ■ | ■ | ■ |
| Crystal Scarabaeus Green F (001 SCGR) | NEW! | ■ | ■ | ■ | ■ | ■ | ■ |

Color of Thread / Net-edge

012 / 112 / 212 Black

022 / 122 / 222 White

Color of Casing

081 Gold

082 Silver

086 Gun Metal

093 Rose Gold

* Art. 55 501 is not available with net-edge. When ordering one row with net-edge, art. 55 500 is to be used.

Metal Trimmings

Metal Components

Rivets

53 001 Rivets



SS SS 29
M 500 PCS **100%**

53 006 Rivets

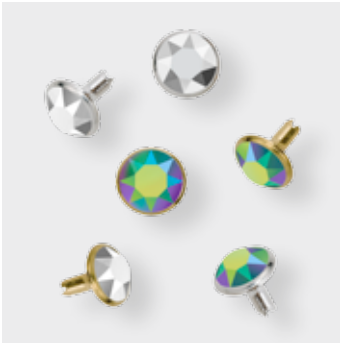

SS SS 39
M 300 PCS **100%**

53 008 Rivets

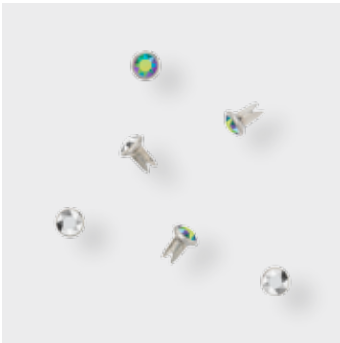

SS PP 24
M 500 PCS **100%**

53 001*
53 006*
53 008/****

| Color of Casing | 081 Gold | 082 Silver | 086 Gun Metal | 093 Rose Gold | 088 Stainless Steel |
|---|----------|------------|---------------|---------------|---------------------|
| Crystal Effects | | | | | |
| Metallic Effects | | | | | |
| ● Crystal Light Chrome F (001 LTCH) | NEW! | ■ | ■ | ■ | ■ |
| ● Crystal Scarabaeus Green F (001 SCGR) | NEW! | ■ | ■ | ■ | ■ |

* For respective Back Parts please refer to the chapter 'Metal Trimmings' in the Swarovski Crystal Collection 2014 (page 605).
** 53 008 is only available in stainless steel.

Metal Trimmings

Metal Components

Rivet Flat Shaft

53 003 Rivet Flat Shaft



| | |
|-----------|------|
| SS SS 29 | |
| M 500 PCS | 100% |

53 003

| Crystal Effects | | Color of Casing | | | |
|--|------|--------------------------|--------------------------|--------------------------|--------------------------|
| Metallic Effects | | 081 Gold | 082 Silver | 086 Gun Metal | 093 Rose Gold |
| <input type="checkbox"/> Crystal Light Chrome F (001 LTCH) | NEW! | <input type="checkbox"/> | <input type="checkbox"/> | <input type="checkbox"/> | <input type="checkbox"/> |
| <input type="checkbox"/> Crystal Scarabaeus Green F (001 SCGR) | NEW! | <input type="checkbox"/> | <input type="checkbox"/> | <input type="checkbox"/> | <input type="checkbox"/> |

UPGRADE ROSE PINS

The name XIRIUS has become synonymous with unmatched brilliance, clarity, and outstanding precision. This outstanding product is now available as Rose Pins in sizes SS16, SS20, and SS34. Rose Pin size SS10 will be available with the XILION Flat Back.

53 301 Rose Pins



| | |
|-----------------|------|
| SS SS 10 (2038) | |
| M 1,440 PCS | 100% |

53 302 Rose Pins



| | |
|-----------------|------|
| SS SS 16 (2078) | |
| M 1,440 PCS | 100% |

53 301
53 302
53 303
53 304

Color of Casing

088 Stainless Steel

Crystal

- Crystal (001)

Colors

Plain Colors

- Black Diamond (215)
- Denim Blue (266)
- Greige (284)
- Jet (280)
- Light Siam (227)
- Rose (209)
- Sapphire (206)

Crystal Effects

Transparent Effects

- Crystal AB (001 AB)
- Crystal Blue Shade (001 BLSH)
- Crystal Golden Shadow (001 GSHA)
- Crystal Silver Night (001 SINI)
- Crystal Silver Shade (001 SSHA)

Metallic Effects

- Crystal Metallic Light Gold (001 MLGLD)
- Crystal Rose Gold (001 ROGL)

Color Effects

Metallic Effects

- Jet Hematite (280 HEM)
- Jet Nut (280 NUT)

53 303 Rose Pins

SS SS 20 (2078)

M 720 PCS

100%

53 304 Rose Pins

SS SS 34 (2078)

M 288 PCS

100%

APPLICATION ADVICE

Rose pins can be easily applied with a fly press or with a semi-automatic attaching machine. For manual application use the same tool as before. For semiautomatic application it is necessary to change the tool. Therefore please directly contact your sales representative.

CARE INSTRUCTIONS

The care instructions are the same as those that apply to the Metal Trimmings articles assortment. Please refer to the Application Manual and or Business Website swarovski.com/professional for detailed information.

53 100 Rose Montées

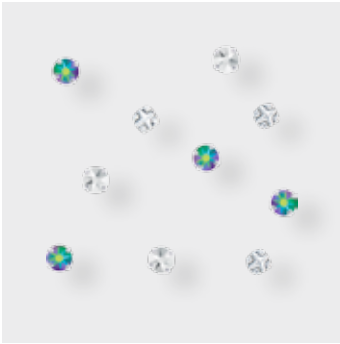

SS SS 12
M 1,440 PCS 100%

53 102 Rose Montées



SS SS 16
M 1,440 PCS 100%

53 203 Chaton Montées

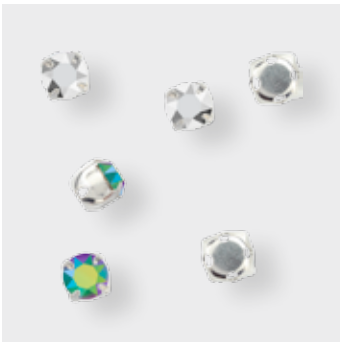

SS SS 29
M 720 PCS 100%

53 100
53 102

Color of Casing

082 Silver
086 Gun Metal
093 Rose Gold

Crystal Effects

Metallic Effects

Crystal Light Chrome F (001 LTCH) NEW!

Crystal Scarabaeus Green F (001 SCGR) NEW!

53 203

Color of Casing

082 Silver
086 Gun Metal
093 Rose Gold

Crystal Effects

Metallic Effects

Crystal Light Chrome F (001 LTCH) NEW!

Crystal Scarabaeus Green F (001 SCGR) NEW!

Crystal Mesh is a flexible metal mesh carrier with integrated loose crystals. The product is available in a wide range of colors and casings, either as a Hotfix version or as a No Hotfix version. Customized solutions are possible with motif choices incorporating up to nine colors.

40 000



| | | |
|----|----------|------|
| SH | 100 | |
| S | ~500x200 | |
| SS | PP 21 | |
| M | 1 SH | 100% |

40 001

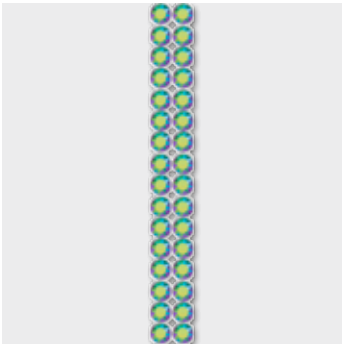

| | | |
|----|---------|------|
| R | 002-033 | |
| SS | PP 21 | |
| M | 10 M | 100% |

40 200

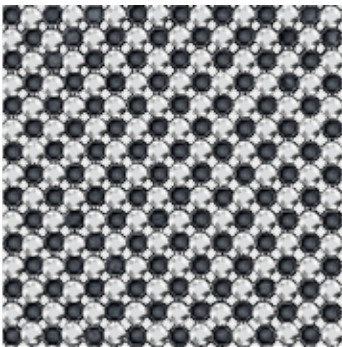

| | | |
|----|----------|------|
| SH | 100 | |
| S | ~500x200 | |
| SS | PP 21 | |
| M | 1 SH | 100% |

40 201

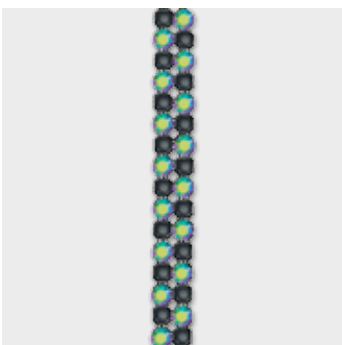

| | | |
|----|---------|------|
| R | 002-033 | |
| SS | PP 21 | |
| M | 10 M | 100% |

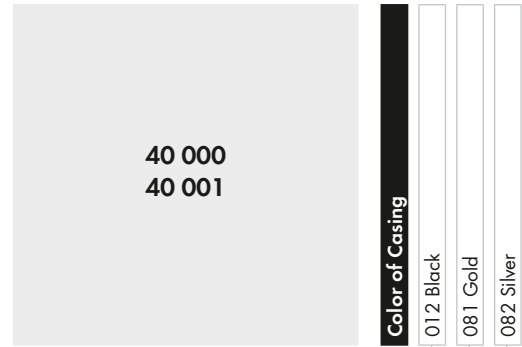

Crystal Effects

Metallic Effects

| | | | | | |
|-----------------------|---------------------------------------|------|--------------------------|--------------------------|--------------------------|
| <input type="radio"/> | Crystal Light Chrome F (001 LTCH) | NEW! | <input type="checkbox"/> | <input type="checkbox"/> | <input type="checkbox"/> |
| <input type="radio"/> | Crystal Scarabaeus Green F (001 SCGR) | NEW! | <input type="checkbox"/> | <input type="checkbox"/> | <input type="checkbox"/> |

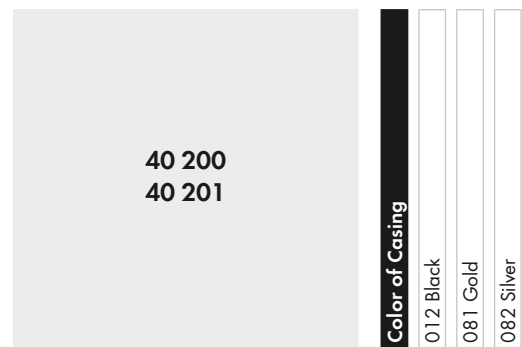

Crystal Effects

Metallic Effects

| | | | | | |
|-----------------------|---------------------------------------|------|--------------------------|--------------------------|--------------------------|
| <input type="radio"/> | Crystal Light Chrome F (001 LTCH) | NEW! | <input type="checkbox"/> | <input type="checkbox"/> | <input type="checkbox"/> |
| <input type="radio"/> | Crystal Scarabaeus Green F (001 SCGR) | NEW! | <input type="checkbox"/> | <input type="checkbox"/> | <input type="checkbox"/> |

Crystal Mesh

40 400



| | |
|----|----------|
| SH | 100 |
| S | ~500x200 |
| SS | PP 14 |
| M | 1 SH |
| | 100% |

40 401

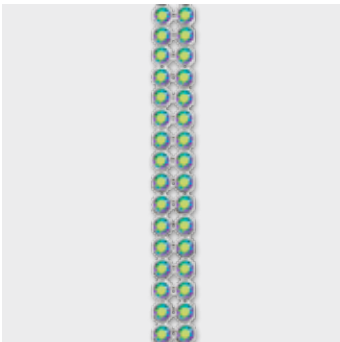

| | |
|----|---------|
| R | 002-033 |
| SS | PP 14 |
| M | 10 M |
| | 100% |

40 600



| | |
|----|----------|
| SH | 100 |
| S | ~500x200 |
| SS | PP 9 |
| M | 1 SH |
| | 100% |

40 601



| | |
|----|---------|
| R | 003-033 |
| SS | PP 9 |
| M | 10 M |
| | 100% |

Crystal Aerial Mesh, Crystal Fine Mesh

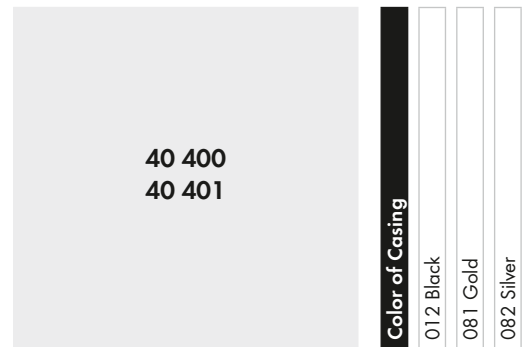

Crystal Effects

Metallic Effects

- Crystal Light Chrome F (001 LTCH) NEW!
- Crystal Scarabaeus Green F (001 SCGR) NEW!

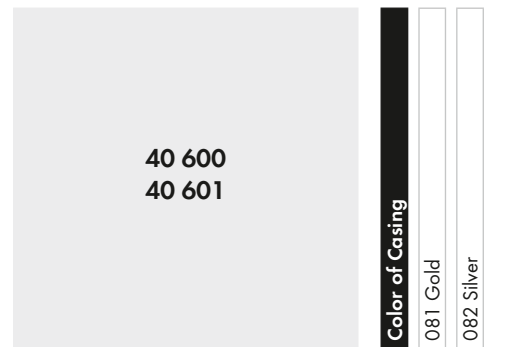

Crystal Effects

Metallic Effects

- Crystal Light Chrome F (001 LTCH) NEW!

CERALUN LINE EXTENSION IN COLOR ASSORTMENT

An absolutely essential material for innovative design has entered a new, colorful age: Ceralun™, the versatile compound for creating artistic pavés, is now available in more colors.

ARTICLE EXPLANATION

Ceralun™ is a versatile and strong two-component, high-performance ceramic epoxy composite. The clay has been specifically developed and tailored to embed foiled and unfoiled crystals. It is an absolutely essential material for innovative design. It will give you new designing possibilities and is a perfect match for the new effects Crystal Scarabaeus Green and Crystal Light Chrome.

Ceralun has a high level of hardness, rigidity, and shock absorbance. It is resistant to perspiration, humidity, or climatic changes and shows no aging.

ORDERING EXAMPLE

9030/400 CERALUN DARK SAPPHIRE 100G EUR

OVERVIEW OF ALL AVAILABLE COLORS AND EFFECTS

| 9030/XXX | 5x20 g | 100 g | 10x100 g | 1 kg Box |
|----------------|--------|-------|----------|----------|
| Dark Sapphire | ✓ | ✓ | ✓ | ✓ |
| Malachite | ✓ | ✓ | ✓ | ✓ |
| Red | ✓ | ✓ | ✓ | ✓ |
| Yellow | ✓ | ✓ | ✓ | ✓ |
| Shinning Green | ✓ | ✓ | ✓ | ✓ |
| Anthracite | ✓ | ✓ | ✓ | ✓ |



APPLICATION ADVICE

When working with Ceralun™, optimal results are obtained by coordinating the entire application process. Following the application steps in the right order is very important. Experience has shown that the most common reasons for crystals becoming detached are inappropriate areas of application, the wrong mixing ratio of the two components, or not mixing them together long enough until a homogenous appearance is achieved. For detailed application process please find more information on our business website SWAROVSKI.COM/PROFESSIONAL

LINE EXTENSION CG-500 CARTRIDGE MIXER

This spare part for the two-component glue CG-500 cartridge (Article Number 9030/125 Europe, 9030/225 America, 9030/325 Asia) will greatly improve application results because in order to press the glue out of the cartridge, the glue has to be mixed optimally.

ORDERING EXAMPLE

9030/126 CG500 mixing nozzle (Cart.2x25g) 10qty

TECHNICAL DETAILS

| Inner Diameter (mm) | Number of Elements | Outer Diameter (mm) | Length (mm) | Approx. Content (ml) |
|---------------------|--------------------|---------------------|-------------|----------------------|
| 4.0 | 16 | 5.9 | 96.0 | 1.20 |



EUROPE

For Austria, Germany, Switzerland, Benelux, Scandinavia, UK, Ireland, France, Spain, Portugal, Greece, Turkey, North Africa and Eastern Europe, please contact **SWAROVSKI INTERNATIONAL DISTRIBUTION AG** Triesen:

SWAROVSKI international distribution ag
Dröschstrasse 15
Postfach 567
9495 Triesen
Liechtenstein
Tel: +423 399 5757
Fax: +423 399 5750
sp.infol@swarovski.com

SWAROVSKI INT.LE D'ITALIA S.P.A. SOCIETA' A SOCIO UNICO
Via Giorgio Giulini n.3
20123 Milano
Italy
Tel: +39 02 722601
sp.IT@swarovski.com

SWAROVSKI OOO
BC "Sadovaya Plaza"
Dolgorukovskaya str., h.7, floor 12
127006 Moscow
Russia
Tel: +7 495 789 68 44
Fax: +7 (495) 258 8903
sp.infol@swarovski.com

SWAROVSKI KRISTAL TIC.LTD.STI.
Abdi İpekçi Cad. Reasürans Han E Blok, No:57 Kat:5
34367 Nişantaşı Şişli, İstanbul
Turkey
Tel: +90 (0) 212 225 44 29
Fax: +90 (0) 212 225 27 99
Swarovski.Turkey@swarovski.com

MIDDLE EAST

SWAROVSKI MIDDLE EAST FZE
P.O. Box 17128, Jebel Ali Free Zone
Dubai
United Arab Emirates
Tel: +971 4 881 6562
Fax: +971 4 881 5623
info.sme@swarovski.com

SWAROVSKI Dubai LLC
P.O. Box 117645
Office No 107, Golf Park Building
Garhoud, Dubai
United Arab Emirates
Tel: +971 4 2822027
Fax: +971 4 2822866
office.dubai@swarovski.com

India Head Office:
Swarovski India Pvt. Ltd.
1st floor, Tower C, DLF Building
No.10,
DLF Cyber City, Phase II
Gurgaon, 122002, India
Tel: +91 124 4698200
+91 124 4698201
konia.khanna@swarovski.com
customer_service.in@swarovski.com

South India Contact Office:
Saleh Center
No. 103, 1st Floor,
18/9 Cunningham Road
Bangalore – 560052
India
Tel: +91 80 30279870
Fax: +91 80 30279866
nirupama.nair@swarovski.com

NORTH & SOUTH AMERICA

SWAROVSKI CRYSTAL COMPONENTS LTDA.
Alameda Itu, 852 - 13º Andar
01421-001 São Paulo – SP
Brazil
Tel: +55 11 3088 8821 (ext. 121)
Fax: +55 11 3088 5976
comercial.br@swarovski.com

SWAROVSKI NORTH AMERICA LTD.
1 Kenney Drive, Cranston
Rhode Island 02920-4400
USA
Tel: +1 401 463 5132
Fax: +1 401 463 4707
Toll free: 1 800 463 0849
sp.sna@swarovski.com

SWAROVSKI NORTH AMERICA LTD.
Los Angeles Showroom,
California Mart
110 East 9th Street, Suite B771
Los Angeles, CA 90079-2827
USA
Tel: +1 213 489 2393
Fax: +1 213 489 1961

SWAROVSKI CRYSTAL S.A. DE C.V., MEXICO
Av. Ejército Nacional No. 579
Piso 11, Local A
Col. Granada
Del. Miguel Hidalgo
C.P. 11520
México D.F.
Tel/Fax: +5255 5545 4509

ASIA

SWAROVSKI HONG KONG LTD.
9th Floor, Fortis Centre,
1063 King's Road
Quarry Bay
Hong Kong
Tel: +852 2566 6301
Fax: +852 2807 1902
sp.infohk@swarovski.com

SWAROVSKI (GUANGZHOU) TRADING COMPANY LTD.
Rm 2401-2403, 24/F, Teemtower,
Teemall
208 Tianhe Road
Guangzhou 510620
China
Tel: +86 20 3813 2188
Fax: +86 20 3810 2278
Toll Free: +86 400 880 1744
sp.infocn@swarovski.com

SWAROVSKI (GUANGZHOU) TRADING COMPANY LTD.
Beijing Liaison Office
Room 2001-2002,
20/F, Tower B, Gemdale Plaza,
No. 91, Jianguo Road,
Chaoyang District,
Beijing 100020
China
Tel: 010-65829773

SWAROVSKI (GUANGZHOU) TRADING COMPANY LTD.
Shanghai Liaison Office
Room 1602,
The Headquarters Building
No. 168, Xi Zang Road (M)
Shanghai 200001
China
Tel: +86 21 2306 9945
Fax: +86 21 6372 9180

SWAROVSKI (GUANGZHOU) TRADING COMPANY LTD.
Qingdao Liaison Office
Art & Technology Space
Room No 1-506
No. 63, Haier Road
Qingdao 266061
China
Tel: +86 532 8099 9595
Fax: +86 532 8099 9596

SWAROVSKI (GUANGZHOU) TRADING COMPANY LTD.
Yiwu Liaison Office
Room 8911, Xinguang International
Business Building
No. 1399, Chouzhou Road (North),
Yiwu City, 322000
Zhejiang Province
China
Tel: +86 579 8559 0903
Fax: +86 579 8559 0707

SWAROVSKI (GUANGZHOU) TRADING COMPANY LTD.
Shenzhen Liaison Office
Room 13G, Tower C, Neo Building
6009 Shennan Avenue,
Futian District
ShenZhen 518048
China
Tel: +86 755 23605750
Fax: +86 755 23605735

Swarovski Taiwan LIMITED TAIWAN BRANCH
3/F, No. 27, Chung-Shan North Road
Section 1, Taipei 104
Taiwan, R.O.C.
Tel: +886 2 2100 2611
Fax: +886 2 2100 2622
sp.infotw@swarovski.com

SWAROVSKI SINGAPORE TRADING PTE. LTD.

2, Alexandra Road
#03-01 Delta House
Singapore 159919
Singapore
Tel: +65 6661 6333
Fax: +65 6274 8177
sp.infosg@swarovski.com

PT CRYSTALLIZED ELEMENTS

Cyber 2 Tower, 31st Floor Unit B
JL. HR. Rasuna Said, Blok X5 No. 13
Jakarta 12950
Indonesia
Tel: +62 21 2902 1451 / 52 / 53
Fax: +62 21 2902 1454
ptcrystallized.id@swarovski.com

Swarovski Singapore Pte. Ltd.

(Vietnam Representative Office)
Level 16 & 17, Gemadept Tower,
6, Le Thanh Ton Street,
Ward Ben Nghe, District 1,
Ho Chi Minh City, Vietnam
Tel: +84 8 62556768
Fax: +84 8 62556801
jeffrey.tan@swarovski.com

SWAROVSKI (THAILAND) LTD.

849 Vorawat Building, 16th Floor,
Room 1601 - 1602,
Silom Road, Silom, Bangrak,
Bangkok 10500
Thailand
Tel: +662 635 1990
Fax: +662 635 1585
sthspmarketing@swarovski.com

SWAROVSKI KOREA LTD.

BaekYoung Building 13F(SP)
(6 Cheongdam-dong) 456 Dosan-
daero, Gangnam-gu,
Seoul, Korea 135-949
Tel: +82 2 6930 9975
Fax: +82 2 3416 0336
amy.kwon@swarovski.com

SWAROVSKI JAPAN LTD.

Shinagawa Grand Central Tower, 3F
2-16-4 Konan, Minato-ku
Tokyo, 108-0075
Japan
Tel: +81 3 6718 2382
Fax: +81 3 6718 2383
sp.infoJP@swarovski.com

NEW ZEALAND

SWAROVSKI INTERNATIONAL (NZ) LTD.

9B Vega Place, Rosedale
North Shore City 0632
New Zealand
Tel: +64 9970 3750
Fax: +61 2 8345 7296
elementsenquiries.sau@swarovski.com

AUSTRALIA

SWAROVSKI INTERNATIONAL (AUSTRALIA) PTY. LTD.

12 Primrose Avenue
P.O. Box 185 (N.S.W 1445)
Rosebery N.S.W. 2018
Australia
Tel: +61 2 8345 7200
Fax: +61 2 9313 6506
daniel.wright@swarovski.com

SWAROVSKI COMMUNICATION & CREATIVE SERVICE CENTERS WORLDWIDE

LONDON

CORPORATE COMMUNICATIONS AND DESIGN SERVICES,

SWAROVSKI CRYSTAL BUSINESS

2nd Floor
21 Sackville Street
London, W1S 3DN
United Kingdom
Tel: +44 (0) 20 7255 8400
Fax: +44 (0) 20 7255 8473
www.swarovski.tv
www.swarovskisparkles.com
www.atelierswarovski.com
www.swarovskicrystalpalace.com

LOS ANGELES

SWAROVSKI NORTH AMERICA LTD.

Los Angeles Showroom,
California Mart
110 E. 9th Street, Suite B771
Los Angeles, CA 90079-2827
USA
Tel: +1 213 489 2393
Fax: +1 213 489 1961

Swarovski Corporate Communications Unit & Creative Services Center
8560 W. Sunset Blvd., Suite 200
West Hollywood, CA 90069
Los Angeles
Tel: +1 310 652 0089 x3813
Fax: +1 310 652 0951

DUBAI

Swarovski Middle East FZE

P. O. Box 17128, Jebel Ali Free Zone
Dubai
United Arab Emirates
Tel: +971 4 881 6562
Fax: +971 4 881 5623
grace.downes@swarovski.com
palak.bhati@swarovski.com

MILAN

SWAROVSKI INT.LE D'ITALIA S.P.A.

SOCIETA' A SOCIO UNICO
Via Giorgio Giulini n.3
20123 Milano
Italy
Tel: +39 02 722601
stefania.fedeli@swarovski.com

NEW YORK

Swarovski Creative Service Center

29 West 57th Street, 8th Floor
New York, NY 10019
USA
Tel: +1 212 935 4200
Fax: +1 212 935 8800
Toll free: 1 877 888 7980

PARIS

Swarovski France S.A.S.

15, Boulevard Poissonnière
75002 Paris
France
Tel: +33 1 4476 1515
cic.france@swarovski.com

SÃO PAULO

Swarovski Crystal Components Ltda.

Alameda Itu, 852-13° Andar
01421-001 São Paulo – SP
Brazil
Tel: +55 11 3088 8821
Fax: +55 11 3088 5976
comercial.br@swarovski.com

WATTENS

D. Swarovski KG
6112 Wattens
Austria
Tel: +43 5224 500 3307
Fax: +43 5224 501 3307
sandra.oconnor@swarovski.com

SWAROVSKI TREND & APPLICATION CENTERS WORLDWIDE

HONG KONG

9th Floor, Fortis Centre,
1063 King's Road
Quarry Bay, Hong Kong
Hong Kong
Tel: +852 2566 6301
Fax: +852 2807 1902

BEIJING

Rm 2001-2002, 20 F, Tower B,
Gemdale Plaza, No. 91,
Jianguo Road, Chaoyang District
Beijing 100020
China
Tel: 010-65829773

SHANGHAI

Room 1602
The Headquarters Building
No. 168, Xi Zang Road (M)
Shanghai 200001
China
Tel: +86 21 2306 9945
Fax: +86 21 6372 9180

GUANGZHOU

Rm 2401-2403, 24/F, Teemtower,
Teemall
208 Tianhe Road
Guangzhou 510620
China
Tel: +86 20 3813 2188
Fax: +86 20 3810 2278
Toll Free: +86 400 880 1744

BANGKOK

Swarovski (Thailand) Ltd.
849 Vorawat Building, 16th Floor,
Room 1601 - 1602,
Silom Road, Silom, Bangrak
Bangkok 10500
Thailand
Tel: +662 635 1990
Fax: +662 635 1585
sirikarn.ngamboosin@swarovski.com

TOKYO JAPAN TAC

Swarovski Japan Ltd.
Shinagawa Grand Central Tower, 3F
2-16-4 Konan, Minato-ku
Tokyo, 108-0075
Japan
Tel: +81 3 6718 2382
Fax: +81 3 6718 2383
sp.infoJP@swarovski.com

General Warning

Loose crystals may present a small parts hazard to young children, particularly children under three years old. Depending on the size of the crystal and any attached material (such as glue, fabric, etc.), children may choke on, inhale, swallow, or insert the crystal into their noses. Magnetic products with crystal applications pose a particular risk of serious intestinal injury if ingested. The application techniques as stated in the Application Manual do not guarantee that crystals will not come loose. For each application, the manufacturer must determine whether the product meets the relevant requirements related to small parts hazards and assess any risk it may pose to small children. Failure to follow Swarovski's care instructions may result in damage to the crystal, which could pose a risk of laceration or other harm.

Warning for Crystal Tattoos

Crystal Tattoos may be applied on healthy skin only. Do not adhere to eyes or on mucous membranes. Crystal Tattoos are not recommended for young children. Loose crystals may present a small parts hazard to young children, particularly children under three years old. If a crystal comes loose, depending on the size of the crystal, children may choke on, inhale, swallow, or insert the crystal into their noses.

Warning for Tableware

Application of loose crystals to tableware presents a potential risk of aspiration, choking, swallowing, or tooth damage should crystals become loose. To reduce this risk, crystals should never be applied to any surface of tableware likely to come in contact with food or the mouth, and crystals should never be placed on any tableware intended for use by children.

Tableware with crystals intended for decorative use only should be marked as such. To avoid dishwasher damage, tableware decorated with crystals should be washed by hand. The application techniques or suggestions in this manual do not guarantee that crystals will not come loose. For each application, the manufacturer must determine whether the product meets relevant requirements related to small parts hazards or use in food contact items and assess any risk it may pose to users.

The use of crystals (which may contain restricted substances deemed hazardous under local laws) and adhesives on tableware is subject to legal restrictions in specific countries. The customer is fully responsible to comply with these country-specific provisions and shall defend, indemnify, and hold Swarovski harmless from any and all third-party claims based on product liability or otherwise relating to uses of Swarovski products and waives all its own claims against Swarovski.

Notice for Application on Packaging

The use of crystal that may contain substances like lead, cadmium or hexavalent chromium, on packaging is subject to legal restrictions in specific countries, including but not limited in regard to the total content of substances based on the proportion between crystal mass to the remaining weight of packaging. The customer is fully responsible to comply with these country-specific provisions and to pass on this information to his customers.

Care Instructions

Failure to follow Swarovski's care instruction may result in damage to the Swarovski product, which could pose a risk of laceration or other harm. Please be informed that all conventional laundering processes (household washing machine as well as professional dry-cleaning) have a considerable mechanical influence onto the garment, which is based on the rotation of the washing drum. The essential requirement for a safety laundering process is that the Swarovski products are properly applied without restrictions regarding the adherence of the Swarovski products. The bigger the size of the used Swarovski product is and the more Swarovski products are applied next to each other, the more a risk of damage has to be taken into consideration. Swarovski products are made of or incorporate crystal and therefore must be handled with due care! Generally, to best protect the Swarovski products from breaking we recommend the use of a soft washing bag and to fill up the washing drum. Turning inside out before washing and selection of a gentle washing program, plus the use of mild detergents are important prerequisites to safeguard the quality of our Swarovski products. Our care instructions based on DIN EN ISO 3758 list up all Swarovski product groups as overview so that each used Swarovski product still needs to be judged in terms of its cleaning suitability for the intended purpose and finished product by the customer. Swarovski's recommendations are given according to the current state of our knowledge and Swarovski's determination of the qualification as textile application product. The customer is therefore fully responsible to determine the cleaning process applicable to the finished product, taking the Swarovski care instructions as well as those of third party materials into account. The variety of shape, cut, surface effect, size and application weight respectively amount of used Swarovski products are decisive for the determination of the suitable cleaning process. To be entirely safe customers respectively dry-cleaners usually take off Sew-on Stones, Buttons, etc. of bigger size before cleaning and re-apply them afterwards.

Unsuitable Applications

Crystals from Swarovski are intended for use in the fields of fashion, jewelry, accessories, textile products, and for interior décor. Due to their physical properties, crystals from Swarovski are unsuitable for other uses (e.g. gluing onto teeth, using crystals on or near mucous membranes, and other unsafe uses). The customer shall defend, indemnify and hold Swarovski harmless from any and all third-party claims based on product liability or otherwise relating to uses of Swarovski products purchased by the customer, and waives all its own claims.

Responsibility of User

Any oral, written, or test-based advice that Swarovski provides regarding techniques for application of its products are recommendations based on Swarovski's current knowledge and the information provided by its suppliers. Such advice does not discharge the customer from carrying out its own tests of techniques it proposes to use and their suitability for the intended application. The application, use, and processing of these techniques and products are solely the user's responsibility.