

## 07

## FLAT BACKS NO HOTFIX

Flat Backs No Hotfix are loose crystal elements backed with platinum foiling for extra brilliance and protection. These Flat Backs are easy to apply to a variety of carrier materials using standard one- or two-component glues. They are available in a multitude of sizes, colors, shapes, and cuts.

The most innovative single item in this product group is art. 2088 XIRIUS Rose, with its most progressive and unique cut in the market: multilayer cut technology creates the inspiring XIRIUS star design. Superior shine and rich, well balanced refraction of light redefine the market standard. Swarovski's outstanding quality in crystal elements are underlined by highest precision in table size and diameter.

COLORS & EFFECTS

OPEN TO SEE COLORS & EFFECTS

## COLORS

	Crystal 001		<u>Air Blue Opal</u> 285
	White Opal 234		Sapphire 206
	Light Silk 261		Capri Blue 243
	Silk 391		Dark Indigo 288
	Light Peach 362		Montana 207
	Rosaline 508		Light Turquoise 263
	Vintage Rose 319		Blue Zircon 229
	Blush Rose 257		Denim Blue 266
	Light Rose 223		Black Diamond 215
	Rose Peach 262		Pacific Opal 390
	Padparadscha 542		<u>Chrysolite Opal</u> 294
	Indian Pink 289		Chrysolite 238
	Fireopal <sup>2</sup> 237		Peridot 214
	Hyacinth 236		Erinite 360
	Light Siam 227		Fern Green 291
	Indian Siam <sup>2</sup> 327		Emerald 205
	Rose 209		Olivine 228
	Fuchsia 502		Greige 284
	Ruby 501		Light Colorado Topaz 246
	Siam 208		Jonquil 213
	Burgundy 515		Citrine 249
	Amethyst 204		Yellow Opal 231
	Purple Velvet 277		Light Topaz 226
	Cobalt 369		Sunflower 292
	Tanzanite 539		Topaz 203
	Light Amethyst 212		Tangerine 259
	Smoky Mauve 265		Smoked Topaz 220
	Provence Lavender 283		Mocca 286
	Light Sapphire 211		Graphite 253
	Aquamarine 202		Jet <sup>1</sup> 280

## EFFECTS

	<u>Crystal Silver Shade</u> 001 SSHA		Crystal Comet Argent Light* 001 CAL
	Crystal Moonlight 001 MOL		Crystal Silver Night** 001 SINI
	Crystal Aurore Boreale 001 AB		Crystal Cosmojet <sup>2</sup> 001 COS
	<u>Crystal Luminous Green*</u> 001 LUMG		Jet Hematite*/ <sup>1</sup> 280 HEM
	Crystal Golden Shadow 001 GSHA	<b>CRYSTAL LACQUER<sup>PRO</sup></b>	
	<u>Crystal Metallic Sunshine*</u> 001 METSH		
	<u>Crystal Rose Gold*</u> 001 ROGL		
	Crystal Copper* 001 COP		
	Light Siam Aurore Boreale 227 AB		
	Light Rose Aurore Boreale 223 AB		
	Crystal Antique Pink* 001 ANTP		
	Rose Aurore Boreale 209 AB		
	Crystal Volcano** 001 VOL		
	<u>Crystal Paradise Shine</u> 001 PARSH		
	Sapphire Aurore Boreale 206 AB		
	Crystal Bermuda Blue** 001 BBL		
	Crystal Metallic Blue* 001 METBL		
	<u>Crystal Meridian Blue**</u> 001 MBL		
	Aquamarine Aurore Boreale 202 AB		
	Crystal Blue Shade* 001 BLSH		
	Peridot Aurore Boreale 214 AB		
	Jonquil Aurore Boreale 213 AB		
	<u>Crystal Scarabaeus Green*/***</u> 001 SCGR		
	<u>Crystal Rainbow Dark*</u> 001 RABDK		
	<u>Crystal Iridescent Green*</u> 001 IRIG		
	Crystal Dorado* 001 DOR		
	Crystal Metallic Light Gold* 001 MLGLD		
	<u>Crystal Bronze Shade*</u> 001 BRSH		
	Topaz Aurore Boreale 203 AB		
	<u>Crystal Light Chrome*</u> 001 LTCH		

## NUMERICAL ORDER

001	Crystal	001 MLGLD	Crystal Metallic Light Gold*	213 AB	Jonquil Aurore Boreale	277	Purple Velvet
001 AB	Crystal Aurore Boreale	001 METSH	Crystal Metallic Sunshine*	214	Peridot	280	Jet <sup>1</sup>
001 ANTP	Crystal Antique Pink*	001 MOL	Crystal Moonlight	214 AB	Peridot Aurore Boreale	280 HEM	Jet Hematite*/ <sup>1</sup>
001 BBL	Crystal Bermuda Blue**	001 PARSH	Crystal Paradise Shine	215	Black Diamond	283	Provence Lavender
001 BLAPA	Crystal Black Patina*	001 RABDK	Crystal Rainbow Dark*	220	Smoked Topaz	284	Greige
001 BLSH	Crystal Blue Shade*	001 ROGL	Crystal Rose Gold*	223	Light Rose	285	Air Blue Opal
001 BRSH	Crystal Bronze Shade*	001 ROSPA	Crystal Rose Patina*	223 AB	Light Rose Aurore Boreale	286	Mocca
001 CAL	Crystal Comet Argent Light*	001 SCGR	Crystal Scarabaeus Green*/***	226	Light Topaz	288	Dark Indigo
001 COP	Crystal Copper*	001 SINI	Crystal Silver Night**	227	Light Siam	289	Light Siam
001 COS	Crystal Cosmojet <sup>2</sup>	001 SILPA	Crystal Silver Patina*	227 AB	Light Siam Aurore Boreale	291	Fern Green
001 DOR	Crystal Dorado*	001 SSHA	Crystal Silver Shade	228	Olivine	292	Sunflower
001 GOLPA	Crystal Gold Patina*	001 VOL	Crystal Volcano**	229	Blue Zircon	294	Chrysolite Opal
001 GSHA	Crystal Golden Shadow	001 WHIPA	Crystal White Patina	231	Yellow Opal	319	Vintage Rose
001 IRIG	Crystal Iridescent Green*	202	Aquamarine	234	White Opal	327	Indian Siam <sup>2</sup>
001 L101	Crystal Powder Yellow*	202 AB	Aquamarine Aurore Boreale	236	Hyacinth	360	Erinite
001 L102	Crystal Powder Green*	203	Topaz	237	Fireopal <sup>2</sup>	362	Light Peach
001 L103	Crystal Powder Rose*	203 AB	Topaz Aurore Boreale	238	Chrysolite	369	Cobalt
001 L104	Crystal Powder Blue*	204	Amethyst	243	Capri Blue	390	Pacific Opal
001 L106S	Crystal Ivory Cream*	205	Emerald	246	Light Colorado Topaz	391	Silk
001 L107S	Crystal Royal Red*	206	Sapphire	249	Citrine	501	Ruby
001 L108S	Crystal Dark Red*	206 AB	Sapphire Aurore Boreale	253	Graphite	502	Fuchsia
001 L109S	Crystal Royal Green*	207	Montana	257	Blush Rose	508	Rosaline
001 L110S	Crystal Royal Blue*	208	Siam	259	Tangerine	515	Burgundy
001 L111S	Crystal Dark Grey*	209	Rose	261	Light Silk	539	Tanzanite
001 LTCH	Crystal Light Chrome*	209 AB	Rose Aurore Boreale	262	Rose Peach	542	Padparadscha
001 LUMG	Crystal Luminous Green*	211	Light Sapphire	263	Light Turquoise		
001 MBL	Crystal Meridian Blue**	212	Light Amethyst	265	Smoky Mauve		
001 METBL	Crystal Metallic Blue*	213	Jonquil	266	Denim Blue		

## ALPHABETICAL ORDER

<u>Air Blue Opal (285)</u>	<u>Crystal Iridescent Green (001 IRIG)*</u>	Emerald (205)	Pacific Opal (390)
Amethyst (204)	<u>Crystal Ivory Cream (001 L106S)*</u>	Erinite (360)	Padparadscha (542)
Aquamarine (202)	<u>Crystal Light Chrome (001 LTCH)*</u>	Fern Green (291)	Peridot (214)
Aquamarine Aurore Boreale (202 AB)	<u>Crystal Luminous Green (001 LUMG)*</u>	Fireopal (237) <sup>2</sup>	Peridot Aurore Boreale (214 AB)
Black Diamond (215)	<u>Crystal Meridian Blue (001 MBL)**</u>	Fuchsia (502)	Provence Lavender (283)
Blue Zircon (229)	Crystal Metallic Blue (001 METBL)*	Graphite (253)	Purple Velvet (277)
Blush Rose (257)	Crystal Metallic Light Gold (001 MLGLD)*	Greige (284)	Rosaline (508)
Burgundy (515)	<u>Crystal Metallic Sunshine (001 METSH)*</u>	Hyacinth (236)	Rose (209)
Capri Blue (243)	Crystal Moonlight (001 MOL)	Indian Pink (289)	Rose Aurore Boreale (209 AB)
Chrysolite (238)	<u>Crystal Paradise Shine (001 PARSH)</u>	Indian Siam (327) <sup>2</sup>	<u>Rose Peach (262)</u>
Chrysolite Opal (294)	Crystal Powder Blue (001 L104)*	Jet (280) <sup>1</sup>	Ruby (501)
Citrine (249)	Crystal Powder Green (001 L102)*	Jet Hematite (280 HEM)*/ <sup>1</sup>	Sapphire (206)
Cobalt (369)	Crystal Powder Rose (001 L103)*	Jonquil (213)	Sapphire Aurore Boreale (206 AB)
Crystal (001)	Crystal Powder Yellow (001 L101)*	Jonquil Aurore Boreale (213 AB)	Siam (208)
Crystal Antique Pink (001 ANTP)*	<u>Crystal Rainbow Dark (001 RABDK)*</u>	Light Amethyst (212)	Silk (391)
Crystal Aurore Boreale (001 AB)	<u>Crystal Rose Patina (001 ROSPA)*</u>	Light Colorado Topaz (246)	Smoked Topaz (220)
Crystal Bermuda Blue (001 BBL)**	<u>Crystal Rose Gold (001 ROGL)*</u>	Light Peach (362)	<u>Smoky Mauve (265)</u>
Crystal Black Patina (001 BLAPA)*	<u>Crystal Royal Blue (001 L110S)*</u>	Light Rose (223)	Sunflower (292)
Crystal Blue Shade (001 BLSH)*	<u>Crystal Royal Green (001 L109S)*</u>	Light Rose Aurore Boreale (223 AB)	<u>Tangerine (259)</u>
Crystal Bronze Shade (001 BRSH)*	<u>Crystal Royal Red (001 L107S)*</u>	Light Sapphire (211)	Tanzanite (539)
Crystal Comet Argent Light (001 CAL)*	<u>Crystal Scarabaeus Green (001 SCGR)*/**</u>	Light Siam (227)	Topaz (203)
Crystal Copper (001 COP)*	Crystal Silver Night (001 SINI)**	Light Siam Aurore Boreale (227 AB)	Topaz Aurore Boreale (203 AB)
Crystal Cosmojet <sup>2</sup> (001 COS) <sup>2</sup>	<u>Crystal Silver Patina (001 SILPA)*</u>	Light Silk (261)	Vintage Rose (319)
Crystal Dark Grey (001 L111S)*	<u>Crystal Silver Shade (001 SSHA)</u>	Light Topaz (226)	White Opal (234)
Crystal Dark Red (001 L108S)*	Crystal Volcano (001 VOL)**	Light Turquoise (263)	<u>Yellow Opal (231)</u>
Crystal Dorado (001 DOR)*	<u>Crystal White Patina (001 WHIPA)</u>	Mocca (286)	
Crystal Gold Patina (001 GOLPA)*	Dark Indigo (288)	Montana (207)	
Crystal Golden Shadow (001 GSHA)	<u>Denim Blue (266)</u>	Olivine (228)	

For details on available colors and effects for each article within the product groups, please see the product matrix of the respective item.  
For color and effect samples, please see the corresponding color chart.

Classic Colors/Effects:  
This color range offers a wide choice of traditional Swarovski crystal colors and effects.

Exclusive Colors/Effects:  
This color range is offered exclusively by Swarovski.

The plating resistance of effects is tested according to Swarovski's plating guidelines (SWAROVSKI.COM/PROFESSIONAL). Customers are advised to carry out their own tests if customers' plating parameters diverge from Swarovski plating guidelines.

\* Crystals are not resistant to plating and similar processing.  
\*\* Crystals are resistant to plating only if they are F-foiled.  
\*\*\* designed by Jean Paul Gaultier  
<sup>1</sup> In these colors art. 2088 is available as foiled or unfoiled version.  
<sup>2</sup> Only available in limited sizes.

Colors and effects can appear different when illuminated with different light sources. Swarovski uses standard light source D50 for color decision and comparison. Slight changes in shades are unavoidable. Colors may vary according to cut and foiling.

The composition of Advanced Crystal is compliant with regulatory industry norms and laws regarding the restriction or prohibition of certain substances in the most relevant segments of our customers. Please note that the compliance of the crystal colors Citrine, Fireopal, Hyacinth, Light Siam, Siam and Yellow Opal vary to certain industry regulations. Those regulations are indicated with an (\*) in the compliance overview. Indian Siam (option to Lt.. Siam) and Tangerine (option to Sun) conform to all CLEAR-lists.











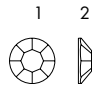
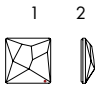
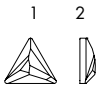



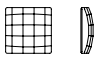

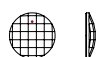























For further information please visit [swarovski.com/professional](http://swarovski.com/professional)

© 2016 D. Swarovski Distribution GmbH



# FLAT BACKS NO HOTFIX

## SUMMARY

	<b>2000</b> SS 3, 4		<b>2420</b> 10, 25 mm		<b>2720</b> 7.5, 9, 12.5 mm
	<b>2006</b> 10, 12, 14, 16 mm		<b>2483</b> 10, 25 mm		<b>2738</b> 10x5, 12x6 mm
	<b>2034</b> SS 10, 20, 48		<b>2493</b> 8, 10, 12, 20, 30 mm		<b>2739</b> 5.8x5.3, 7x6.5 mm
	<b>2035</b> 6, 10, 14, 20, 30, 40 mm		<b>2494</b> 6, 8, 10.5 mm		<b>2740</b> 8.3x8.3, 10x10 mm
	<b>2037</b> 8, 14, 17 mm		<b>2520</b> 8x6, 10x8, 14x10 mm		<b>2753</b> 10, 14 mm
	<b>2058</b> SS 5, 6, 7, 8, 9, 10		<b>2540</b> 7x5.5, 9x7, 12x9.5 mm		<b>2753/G</b> 10, 14 mm
	<b>2072</b> 8, 10, 12 mm		<b>2555</b> 8x2.6, 12x4, 15x5 mm		<b>2770</b> 6x3.5, 12x7 mm
	<b>2088</b> SS 12, 14, 16, 20, 30, 34, 40, 48		<b>2570</b> 50x16 mm		<b>2788</b> 8, 10 mm
	<b>2088/G</b> SS 20, 34		<b>2585</b> 8, 10, 14 mm		<b>DESIGNER EDITION</b> <b>2797</b> 8x4, 10x5 mm
	<b>2200</b> 8x4 mm		<b>2611</b> 8, 10, 14 mm		<b>2798</b> 8, 10, 14 mm
	<b>2204</b> 6x4.8, 10x8, 14x11 mm		<b>DESIGNER EDITION</b> <b>2612</b> 6, 10, 14 mm		<b>2808</b> 6, 10, 14 mm
	<b>2205</b> 7.5, 10, 14 mm		<b>2708</b> 8x8.7, 12.5x13.6 mm		<b>2813</b> 8x5.5, 10x7, 14x9.5 mm
	<b>2300</b> 8x4.8, 10x6 mm		<b>2709</b> 10x6, 13x8 mm		<b>2816</b> 5 mm
	<b>2304</b> 6x1.7, 10x2.8, 14x3.9 mm		<b>2714</b> 6, 10, 14 mm		<b>2826</b> 5 mm
	<b>2400</b> 3, 4, 6 mm		<b>2716</b> 5 mm		<b>2854</b> 8, 12 mm
					<b>2858</b> 6x4.5, 9x6.5, 12x8.5 mm

1 Top view 2 Side view  
 • The logo position is marked by a red dot.

# FLAT BACKS NO HOTFIX

07 FLAT BACKS NO HOTFIX

## 2000 Rose Flat Back

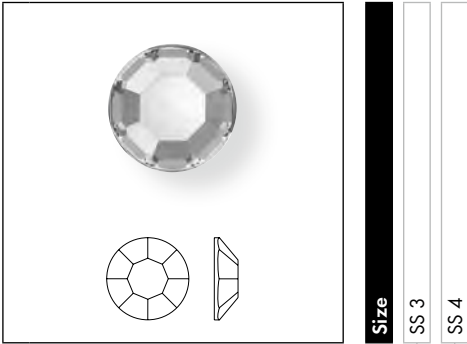

Size  
SS 3  
SS 4

Crystal	
Crystal F (001)	■ ■
Colors	
Plain Colors	
Amethyst F (204)	■
Aquamarine F (202)	■
Black Diamond F (215)	■
Indian Siam F (327)	■
Jet (280)	■
Jonquil F (213)	■
Light Colorado Topaz F (246)	■
Light Rose F (223)	■
Montana F (207)	■
Peridot F (214)	■
Smoked Topaz F (220)	■
Crystal Effects	
Transparent Effects	
Crystal AB F (001 AB)	■ ■
Crystal Golden Shadow F (001 GSHA)	■
Crystal Silver Shade F (001 SSHA)	■
Metallic Effects	
Crystal Metallic Blue F (001 METBL)	■
Crystal Metallic Light Gold F (001 MLGLD)	■
Crystal Rose Gold F (001 ROGL)	■
Color Effects	
Metallic Effects	
Jet Hematite F (280 HEM)	■

## 2006 Rivoli Flat Back

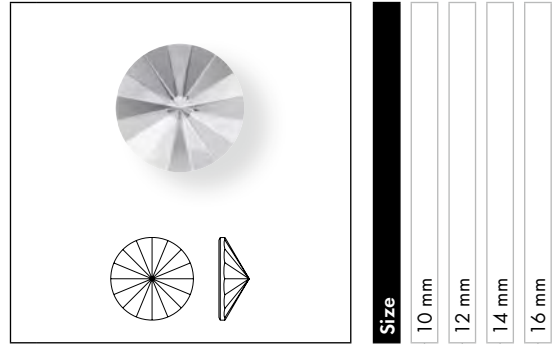

Size  
10 mm  
12 mm  
14 mm  
16 mm

Crystal	
Crystal F (001)	■ ■ ■ ■

# FLAT BACKS NO HOTFIX

## 2034 Concise Flat Back

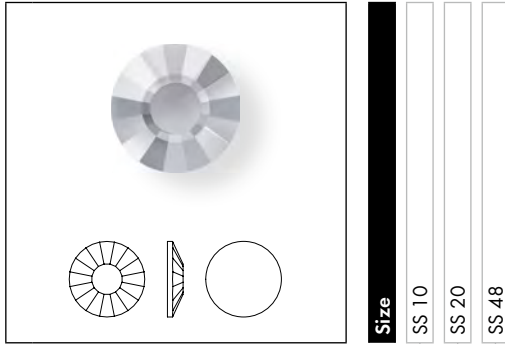

Crystal	SS 10	SS 20	SS 48
Crystal F (001)	■	■	■
<b>Colors</b>			
<b>Plain Colors</b>			
Jet F (280)	■	■	■
Light Siam F (227)	■	■	■
<b>Crystal Effects</b>			
<b>Transparent Effects</b>			
Crystal AB F (001 AB)	■	■	■
Crystal Golden Shadow F (001 GSHA)	■	■	■
<b>Metallic Effects</b>			
Crystal Light Chrome F (001 LTCH)	■	■	■
<b>Crystal Patina Effect</b>			
Crystal Black Patina F (001 BLAPA)	■	■	■
Crystal Rose Patina F (001 ROSPA)	■	■	■
<b>Color Effects</b>			
<b>Transparent Effects</b>			
Light Siam AB F (227 AB)	■	■	■

## 2035 Chessboard Circle Flat Back

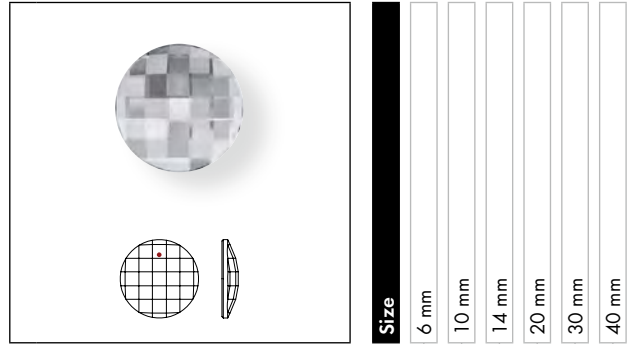

Crystal	6 mm	10 mm	14 mm	20 mm	30 mm	40 mm
Crystal F (001)	■	■	■	■	■	■
Crystal CAL V SI (001 CAL V SI) <sup>1</sup>				■	■	■
<b>Colors</b>						
<b>Plain Colors</b>						
Aquamarine F (202)	■	■	■			
Black Diamond F (215)	■	■	■	■		
Jet (280)	■	■	■	■		
<b>Crystal Effects</b>						
<b>Transparent Effects</b>						
Crystal AB F (001 AB)	■	■				
Crystal Antique Pink F (001 ANTP)	■	■				
Crystal Golden Shadow F (001 GSHA)	■	■	■	■		

## 2037 Eclipse Flat Back

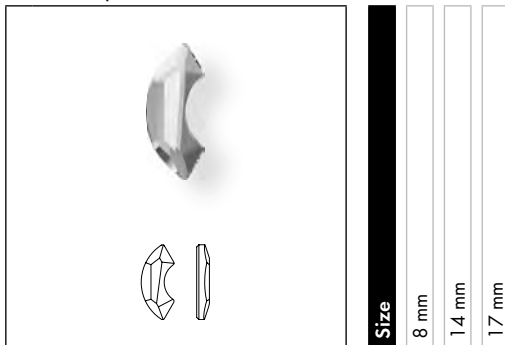

Crystal	8 mm	14 mm	17 mm
Crystal F (001)	■	■	■

<sup>1</sup> Articles integrated from the former Bath & Wellness Collection may be partly delivered with a laser-engraved logo.

• The logo position is marked by a red dot.

<sup>2</sup> Coated on faceted side.



# FLAT BACKS NO HOTFIX

## 2058 XILLION Rose Enhanced

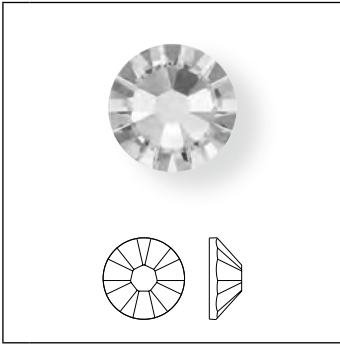

Size

SS 5

SS 6

SS 7

SS 8

SS 9

SS 10

### Crystal

Crystal F (001)

### Colors

#### Plain Colors

Amethyst F (204)

Aquamarine F (202)

Black Diamond F (215)

Blue Zircon F (229)

Blush Rose F (257)

Burgundy F (515)

Capri Blue F (243)

Chrysolite F (238)

Citrine F (249)

Cobalt F (369)

Dark Indigo F (288)

Denim Blue F (266)

Emerald F (205)

Erinite F (360)

Fern Green F (291)

Fuchsia F (502)

Graphite F (253)

Greige F (284)

Hyacinth F (236)

Indian Pink F (289)

Indian Siam F (327)

Jet (280)

Jet F (280)

Jonquil F (213)

Light Amethyst F (212)

Light Colorado Topaz F (246)

Light Peach F (362)

Light Rose F (223)

Light Sapphire F (211)

Light Siam F (227)

Light Silk F (261)

Light Topaz F (226)

Light Turquoise F (263)

Mocca F (286)

Montana F (207)

Olivine F (228)

Padparadscha F (542)

Peridot F (214)

07 FLAT BACKS NO HOTFIX

# FLAT BACKS NO HOTFIX

2058		Size	SS 5	SS 6	SS 7	SS 8	SS 9	SS 10
	Provence Lavender F (283)		■		■		■	
	Purple Velvet F (277)		■		■		■	
	Rose F (209)		■	■	■		■	■
	Rose Peach F (262)		■		■		■	
	Ruby F (501)		■		■		■	■
	Sapphire F (206)		■	■	■		■	■
	Siam F (208)		■		■		■	■
	Silk F (391)		■		■		■	
	Smoked Topaz F (220)		■		■		■	■
	Smoky Mauve F (265)		■		■		■	
	Sunflower F (292)		■		■		■	
	Tangerine F (259)		■		■		■	
	Tanzanite F (539)		■		■		■	■
	Topaz F (203)		■		■		■	■
	Vintage Rose F (319)		■		■		■	
<b>Opal Colors</b>								
	Air Blue Opal F (285)		■		■		■	
	Chrysolite Opal F (294)		■		■		■	
	Pacific Opal F (390)		■		■		■	
	White Opal F (234)		■		■		■	
	Yellow Opal F (231)		■		■		■	
<b>Crystal Effects</b>								
<b>Transparent Effects</b>								
	Crystal AB F (001 AB)		■	■	■	■	■	■
	Crystal Antique Pink F (001 ANTP)		■		■		■	
	Crystal Blue Shade F (001 BLSH)		■		■		■	
	Crystal Bronze Shade F (001 BRSH)		■		■		■	
	Crystal Copper F (001 COP)		■		■		■	
	Crystal Cosmojet F (001 COS)		■		■		■	
	Crystal Golden Shadow F (001 GSHA)		■		■		■	
	Crystal Luminous Green F (001 LUMG)		■		■		■	
	Crystal Meridian Blue F (001 MBL)		■		■		■	
	Crystal Moonlight F (001 MOL)		■		■		■	
	Crystal Paradise Shine F (001 PARSH)		■		■		■	
	Crystal Silver Night F (001 SINI)		■		■		■	
	Crystal Silver Shade F (001 SSHA)		■		■		■	
	Crystal Volcano F (001 VOL)		■		■		■	
<b>Metallic Effects</b>								
	Crystal Dorado F (001 DOR)		■		■		■	
	Crystal Iridescent Green F (001 IRIG)		■		■		■	
	Crystal Light Chrome F (001 LTCH)		■		■		■	
	Crystal Metallic Blue F (001 METBL)		■		■		■	

# FLAT BACKS NO HOTFIX

07 FLAT BACKS NO HOTFIX

2058		Size	SS 5	SS 6	SS 7	SS 8	SS 9	SS 10
	Crystal Metallic Light Gold F (001 MLGLD)		■		■		■	
	Crystal Metallic Sunshine F (001 METSH)		■		■		■	
	Crystal Rainbow Dark F (001 RABDK)		■		■		■	
	Crystal Rose Gold F (001 ROGL)		■		■		■	
	Crystal Scarabaeus Green*** F (001 SCGR)		■		■		■	
<b>Color Effects</b>								
<b>Transparent Effects</b>								
	Aquamarine AB F (202 AB)		■		■		■	
	Jonquil AB F (213 AB)		■		■		■	
	Light Rose AB F (223 AB)		■		■		■	
	Light Siam AB F (227 AB)		■		■		■	
	Peridot AB F (214 AB)		■		■		■	
	Rose AB F (209 AB)		■		■		■	
	Sapphire AB F (206 AB)		■		■		■	
	Topaz AB F (203 AB)		■		■		■	
<b>Metallic Effects</b>								
	Jet Hematite (280 HEM)		■	■	■		■	■
	Jet Hematite F (280 HEM)		■	■	■		■	■

## 2072 Rose Cut Flat Back

2072 Rose Cut Flat Back		Size	8 mm	10 mm	12 mm
	Crystal F (001)		■	■	■
<b>Colors</b>					
<b>Plain Colors</b>					
	Jet (280)		■		

\*\*\* designed by Jean Paul Gaultier

# FLAT BACKS NO HOTFIX

## 2088 XIRIUS Rose

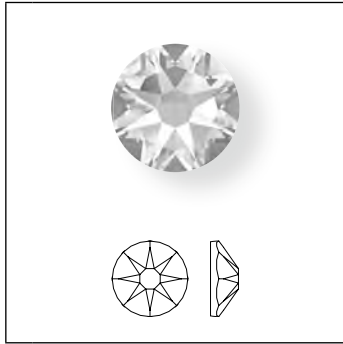

Size

SS 12  
SS 14  
SS 16  
SS 20  
SS 30  
SS 34  
SS 40  
SS 48

### Crystal

<input type="checkbox"/> Crystal F (001)	<input checked="" type="checkbox"/>	<input checked="" type="checkbox"/>	<input checked="" type="checkbox"/>	<input checked="" type="checkbox"/>	<input checked="" type="checkbox"/>	<input checked="" type="checkbox"/>	<input checked="" type="checkbox"/>
--	-------------------------------------	-------------------------------------	-------------------------------------	-------------------------------------	-------------------------------------	-------------------------------------	-------------------------------------

### Colors

#### Plain Colors

<input type="checkbox"/> Amethyst F (204)	<input checked="" type="checkbox"/>	<input checked="" type="checkbox"/>	<input checked="" type="checkbox"/>	<input checked="" type="checkbox"/>	<input checked="" type="checkbox"/>	<input checked="" type="checkbox"/>	<input checked="" type="checkbox"/>
<input type="checkbox"/> Aquamarine F (202)	<input checked="" type="checkbox"/>	<input checked="" type="checkbox"/>	<input checked="" type="checkbox"/>	<input checked="" type="checkbox"/>	<input checked="" type="checkbox"/>	<input checked="" type="checkbox"/>	<input checked="" type="checkbox"/>
<input type="checkbox"/> Black Diamond F (215)	<input checked="" type="checkbox"/>	<input checked="" type="checkbox"/>	<input checked="" type="checkbox"/>	<input checked="" type="checkbox"/>	<input checked="" type="checkbox"/>	<input checked="" type="checkbox"/>	<input checked="" type="checkbox"/>
<input type="checkbox"/> Blue Zircon F (229)	<input checked="" type="checkbox"/>	<input checked="" type="checkbox"/>	<input checked="" type="checkbox"/>	<input checked="" type="checkbox"/>	<input checked="" type="checkbox"/>	<input checked="" type="checkbox"/>	<input checked="" type="checkbox"/>
<input type="checkbox"/> Blush Rose F (257)	<input checked="" type="checkbox"/>	<input checked="" type="checkbox"/>	<input checked="" type="checkbox"/>	<input checked="" type="checkbox"/>	<input checked="" type="checkbox"/>	<input checked="" type="checkbox"/>	<input checked="" type="checkbox"/>
<input type="checkbox"/> Burgundy F (515)	<input checked="" type="checkbox"/>	<input checked="" type="checkbox"/>	<input checked="" type="checkbox"/>	<input checked="" type="checkbox"/>	<input checked="" type="checkbox"/>	<input checked="" type="checkbox"/>	<input checked="" type="checkbox"/>
<input type="checkbox"/> Capri Blue F (243)	<input checked="" type="checkbox"/>	<input checked="" type="checkbox"/>	<input checked="" type="checkbox"/>	<input checked="" type="checkbox"/>	<input checked="" type="checkbox"/>	<input checked="" type="checkbox"/>	<input checked="" type="checkbox"/>
<input type="checkbox"/> Chrysolite F (238)	<input checked="" type="checkbox"/>	<input checked="" type="checkbox"/>	<input checked="" type="checkbox"/>	<input checked="" type="checkbox"/>	<input checked="" type="checkbox"/>	<input checked="" type="checkbox"/>	<input checked="" type="checkbox"/>
<input type="checkbox"/> Citrine F (249)	<input checked="" type="checkbox"/>	<input checked="" type="checkbox"/>	<input checked="" type="checkbox"/>	<input checked="" type="checkbox"/>	<input checked="" type="checkbox"/>	<input checked="" type="checkbox"/>	<input checked="" type="checkbox"/>
<input type="checkbox"/> Cobalt F (369)	<input checked="" type="checkbox"/>	<input checked="" type="checkbox"/>	<input checked="" type="checkbox"/>	<input checked="" type="checkbox"/>	<input checked="" type="checkbox"/>	<input checked="" type="checkbox"/>	<input checked="" type="checkbox"/>
<input type="checkbox"/> Dark Indigo F (288)	<input checked="" type="checkbox"/>	<input checked="" type="checkbox"/>	<input checked="" type="checkbox"/>	<input checked="" type="checkbox"/>	<input checked="" type="checkbox"/>	<input checked="" type="checkbox"/>	<input checked="" type="checkbox"/>
<input type="checkbox"/> Denim Blue F (266)	<input checked="" type="checkbox"/>	<input checked="" type="checkbox"/>	<input checked="" type="checkbox"/>	<input checked="" type="checkbox"/>	<input checked="" type="checkbox"/>	<input checked="" type="checkbox"/>	<input checked="" type="checkbox"/>
<input type="checkbox"/> Emerald F (205)	<input checked="" type="checkbox"/>	<input checked="" type="checkbox"/>	<input checked="" type="checkbox"/>	<input checked="" type="checkbox"/>	<input checked="" type="checkbox"/>	<input checked="" type="checkbox"/>	<input checked="" type="checkbox"/>
<input type="checkbox"/> Eriuite F (360)	<input checked="" type="checkbox"/>	<input checked="" type="checkbox"/>	<input checked="" type="checkbox"/>	<input checked="" type="checkbox"/>	<input checked="" type="checkbox"/>	<input checked="" type="checkbox"/>	<input checked="" type="checkbox"/>
<input type="checkbox"/> Fern Green F (291)	<input checked="" type="checkbox"/>	<input checked="" type="checkbox"/>	<input checked="" type="checkbox"/>	<input checked="" type="checkbox"/>	<input checked="" type="checkbox"/>	<input checked="" type="checkbox"/>	<input checked="" type="checkbox"/>
<input type="checkbox"/> Fireopal F (237)	<input checked="" type="checkbox"/>	<input checked="" type="checkbox"/>	<input checked="" type="checkbox"/>	<input checked="" type="checkbox"/>	<input checked="" type="checkbox"/>	<input checked="" type="checkbox"/>	<input checked="" type="checkbox"/>
<input type="checkbox"/> Fuchsia F (502)	<input checked="" type="checkbox"/>	<input checked="" type="checkbox"/>	<input checked="" type="checkbox"/>	<input checked="" type="checkbox"/>	<input checked="" type="checkbox"/>	<input checked="" type="checkbox"/>	<input checked="" type="checkbox"/>
<input type="checkbox"/> Graphite F (253)	<input checked="" type="checkbox"/>	<input checked="" type="checkbox"/>	<input checked="" type="checkbox"/>	<input checked="" type="checkbox"/>	<input checked="" type="checkbox"/>	<input checked="" type="checkbox"/>	<input checked="" type="checkbox"/>
<input type="checkbox"/> Greige F (284)	<input checked="" type="checkbox"/>	<input checked="" type="checkbox"/>	<input checked="" type="checkbox"/>	<input checked="" type="checkbox"/>	<input checked="" type="checkbox"/>	<input checked="" type="checkbox"/>	<input checked="" type="checkbox"/>
<input type="checkbox"/> Hyacinth F (236)	<input checked="" type="checkbox"/>	<input checked="" type="checkbox"/>	<input checked="" type="checkbox"/>	<input checked="" type="checkbox"/>	<input checked="" type="checkbox"/>	<input checked="" type="checkbox"/>	<input checked="" type="checkbox"/>
<input type="checkbox"/> Indian Pink F (289)	<input checked="" type="checkbox"/>	<input checked="" type="checkbox"/>	<input checked="" type="checkbox"/>	<input checked="" type="checkbox"/>	<input checked="" type="checkbox"/>	<input checked="" type="checkbox"/>	<input checked="" type="checkbox"/>
<input type="checkbox"/> Indian Siam F (327)	<input checked="" type="checkbox"/>	<input checked="" type="checkbox"/>	<input checked="" type="checkbox"/>	<input checked="" type="checkbox"/>	<input checked="" type="checkbox"/>	<input checked="" type="checkbox"/>	<input checked="" type="checkbox"/>
<input type="checkbox"/> Jet (280)	<input checked="" type="checkbox"/>	<input checked="" type="checkbox"/>	<input checked="" type="checkbox"/>	<input checked="" type="checkbox"/>	<input checked="" type="checkbox"/>	<input checked="" type="checkbox"/>	<input checked="" type="checkbox"/>
<input type="checkbox"/> Jet F (280)	<input checked="" type="checkbox"/>	<input checked="" type="checkbox"/>	<input checked="" type="checkbox"/>	<input checked="" type="checkbox"/>	<input checked="" type="checkbox"/>	<input checked="" type="checkbox"/>	<input checked="" type="checkbox"/>
<input type="checkbox"/> Jonquil F (213)	<input checked="" type="checkbox"/>	<input checked="" type="checkbox"/>	<input checked="" type="checkbox"/>	<input checked="" type="checkbox"/>	<input checked="" type="checkbox"/>	<input checked="" type="checkbox"/>	<input checked="" type="checkbox"/>
<input type="checkbox"/> Light Amethyst F (212)	<input checked="" type="checkbox"/>	<input checked="" type="checkbox"/>	<input checked="" type="checkbox"/>	<input checked="" type="checkbox"/>	<input checked="" type="checkbox"/>	<input checked="" type="checkbox"/>	<input checked="" type="checkbox"/>
<input type="checkbox"/> Light Colorado Topaz F (246)	<input checked="" type="checkbox"/>	<input checked="" type="checkbox"/>	<input checked="" type="checkbox"/>	<input checked="" type="checkbox"/>	<input checked="" type="checkbox"/>	<input checked="" type="checkbox"/>	<input checked="" type="checkbox"/>
<input type="checkbox"/> Light Peach F (362)	<input checked="" type="checkbox"/>	<input checked="" type="checkbox"/>	<input checked="" type="checkbox"/>	<input checked="" type="checkbox"/>	<input checked="" type="checkbox"/>	<input checked="" type="checkbox"/>	<input checked="" type="checkbox"/>
<input type="checkbox"/> Light Rose F (223)	<input checked="" type="checkbox"/>	<input checked="" type="checkbox"/>	<input checked="" type="checkbox"/>	<input checked="" type="checkbox"/>	<input checked="" type="checkbox"/>	<input checked="" type="checkbox"/>	<input checked="" type="checkbox"/>
<input type="checkbox"/> Light Sapphire F (211)	<input checked="" type="checkbox"/>	<input checked="" type="checkbox"/>	<input checked="" type="checkbox"/>	<input checked="" type="checkbox"/>	<input checked="" type="checkbox"/>	<input checked="" type="checkbox"/>	<input checked="" type="checkbox"/>
<input type="checkbox"/> Light Siam F (227)	<input checked="" type="checkbox"/>	<input checked="" type="checkbox"/>	<input checked="" type="checkbox"/>	<input checked="" type="checkbox"/>	<input checked="" type="checkbox"/>	<input checked="" type="checkbox"/>	<input checked="" type="checkbox"/>
<input type="checkbox"/> Light Silk F (261)	<input checked="" type="checkbox"/>	<input checked="" type="checkbox"/>	<input checked="" type="checkbox"/>	<input checked="" type="checkbox"/>	<input checked="" type="checkbox"/>	<input checked="" type="checkbox"/>	<input checked="" type="checkbox"/>
<input type="checkbox"/> Light Topaz F (226)	<input checked="" type="checkbox"/>	<input checked="" type="checkbox"/>	<input checked="" type="checkbox"/>	<input checked="" type="checkbox"/>	<input checked="" type="checkbox"/>	<input checked="" type="checkbox"/>	<input checked="" type="checkbox"/>
<input type="checkbox"/> Light Turquoise F (263)	<input checked="" type="checkbox"/>	<input checked="" type="checkbox"/>	<input checked="" type="checkbox"/>	<input checked="" type="checkbox"/>	<input checked="" type="checkbox"/>	<input checked="" type="checkbox"/>	<input checked="" type="checkbox"/>
<input type="checkbox"/> Mocca F (286)	<input checked="" type="checkbox"/>	<input checked="" type="checkbox"/>	<input checked="" type="checkbox"/>	<input checked="" type="checkbox"/>	<input checked="" type="checkbox"/>	<input checked="" type="checkbox"/>	<input checked="" type="checkbox"/>
<input type="checkbox"/> Montana F (207)	<input checked="" type="checkbox"/>	<input checked="" type="checkbox"/>	<input checked="" type="checkbox"/>	<input checked="" type="checkbox"/>	<input checked="" type="checkbox"/>	<input checked="" type="checkbox"/>	<input checked="" type="checkbox"/>
<input type="checkbox"/> Olivine F (228)	<input checked="" type="checkbox"/>	<input checked="" type="checkbox"/>	<input checked="" type="checkbox"/>	<input checked="" type="checkbox"/>	<input checked="" type="checkbox"/>	<input checked="" type="checkbox"/>	<input checked="" type="checkbox"/>
<input type="checkbox"/> Padparadscha F (542)	<input checked="" type="checkbox"/>	<input checked="" type="checkbox"/>	<input checked="" type="checkbox"/>	<input checked="" type="checkbox"/>	<input checked="" type="checkbox"/>	<input checked="" type="checkbox"/>	<input checked="" type="checkbox"/>

# FLAT BACKS NO HOTFIX

07 FLAT BACKS NO HOTFIX

2088		Size	SS 12	SS 14	SS 16	SS 20	SS 30	SS 34	SS 40	SS 48
Peridot F (214)			■		■	■	■	■		
Provence Lavender F (283)			■		■	■	■			
Purple Velvet F (277)			■		■	■	■	■		
Rose F (209)			■		■	■	■	■		
Rose Peach F (262)			■		■	■	■	■		
Ruby F (501)			■		■	■	■	■		
Sapphire F (206)			■		■	■	■	■		
Siam F (208)			■		■	■	■	■		
Silk F (391)			■		■	■	■	■		
Smoked Topaz F (220)			■		■	■	■	■		
Smoky Mauve F (265)			■		■	■	■	■		
Sunflower F (292)			■		■	■	■	■		
Tangerine F (259)			■		■	■	■	■		
Tanzanite F (539)			■		■	■	■	■		
Topaz F (203)			■		■	■	■	■		
Vintage Rose F (319)			■		■	■	■	■		
<b>Opal Colors</b>										
Air Blue Opal F (285)			■		■	■	■	■		
Chrysolite Opal F (294)			■		■	■	■			
Pacific Opal F (390)			■		■	■	■	■		
White Opal F (234)			■		■	■	■	■		
Yellow Opal F (231)			■		■	■	■	■		
<b>Crystal Effects</b>										
<b>Transparent Effects</b>										
Crystal AB F (001 AB)			■	■	■	■	■	■	■	■
Crystal Antique Pink F (001 ANTP)			■		■	■	■	■		
Crystal Blue Shade F (001 BLSH)			■		■	■	■	■		
Crystal Bronze Shade F (001 BRSH)			■		■	■	■			
Crystal Copper F (001 COP)			■		■	■	■	■		
Crystal Cosmojet F (001 COS)			■							
Crystal Golden Shadow F (001 GSHA)			■		■	■	■	■		
Crystal Luminous Green F (001 LUMG)			■		■	■	■	■		
Crystal Meridian Blue F (001 MBL)			■		■	■	■			
Crystal Moonlight F (001 MOL)			■		■	■	■	■		
Crystal Paradise Shine F (001 PARSH)			■		■	■	■	■		
Crystal Silver Night F (001 SINI)			■		■	■	■	■		
Crystal Silver Shade F (001 SSHA)			■		■	■	■	■		
Crystal Volcano F (001 VOL)			■		■	■				
<b>Metallic Effects</b>										
Crystal Dorado F (001 DOR)			■		■	■	■	■		
Crystal Iridescent Green F (001 IRIG)			■		■	■	■	■		
Crystal Light Chrome F (001 LTCH)			■		■	■	■	■		

# FLAT BACKS NO HOTFIX

2088	Size	SS 12	SS 14	SS 16	SS 20	SS 30	SS 34	SS 40	SS 48
	Crystal Metallic Blue F (001 METBL)		■		■	■	■	■	
Crystal Metallic Light Gold F (001 MLGLD)		■		■	■	■	■		
Crystal Metallic Sunshine F (001 METSH)		■		■	■	■	■		
Crystal Rainbow Dark F (001 RABDK)		■		■	■	■	■		
Crystal Rose Gold F (001 ROGL)		■		■	■	■	■		
Crystal Scarabaeus Green*** F (001 SCGR)		■		■	■	■	■		
<b>Crystal Lacquer<sup>PRO</sup></b>									
Crystal Powder Blue (001 L104)		■		■	■	■	■		
Crystal Powder Green (001 L102)		■		■	■	■	■		
Crystal Powder Rose (001 L103)		■		■	■	■	■		
Crystal Powder Yellow (001 L101)		■		■	■	■	■		
Crystal Dark Grey (001 L111S)		■		■	■	■	■		
Crystal Dark Red (001 L108S)		■		■	■	■	■		
Crystal Ivory Cream (001 L106S)		■		■	■	■	■		
Crystal Royal Blue (001 L110S)		■		■	■	■	■		
Crystal Royal Green (001 L109S)		■		■	■	■	■		
Crystal Royal Red (001 L107S)		■		■	■	■	■		
<b>Color Effects</b>									
<b>Transparent Effects</b>									
Aquamarine AB F (202 AB)		■		■	■	■	■		
Jonquil AB F (213 AB)		■		■	■	■	■		
Light Rose AB F (223 AB)		■		■	■	■	■		
Light Siam AB F (227 AB)		■		■	■	■	■		
Peridot AB F (214 AB)		■		■	■	■	■		
Rose AB F (209 AB)		■		■	■	■	■		
Sapphire AB F (206 AB)		■		■	■	■	■		
Topaz AB F (203 AB)		■		■	■	■	■		
<b>Metallic Effects</b>									
Jet Hematite (280 HEM)		■		■	■	■	■		
Jet Hematite F (280 HEM)		■		■	■	■	■		

\*\*\* designed by Jean Paul Gaultier

FLAT BACKS NO HOTFIX

2088/G XIRIUS Rose partly frosted

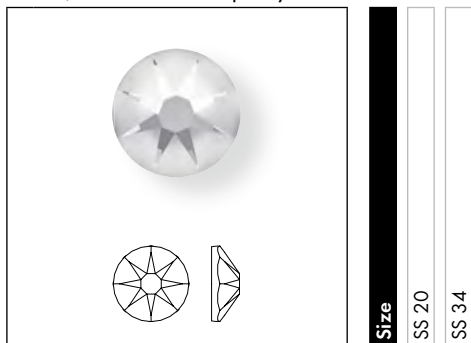

- Crystal**
- Crystal F (001)
- Colors**
- Plain Colors**
- Jet F (280)

<b>Size</b>		
	SS 20	SS 34

2200 Navette Flat Back

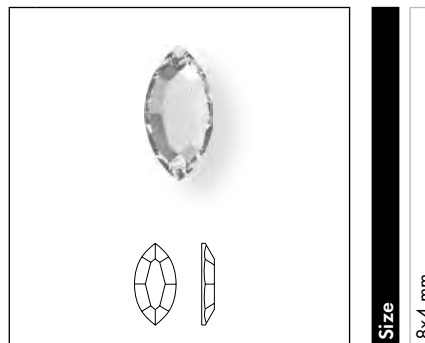

- Crystal**
- Crystal F (001)

<b>Size</b>	
	8x4 mm

2204 Pure Leaf Flat Back

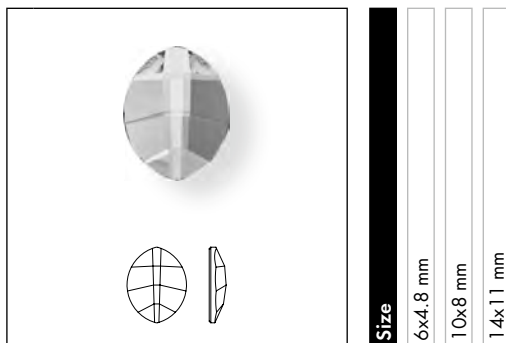

- Crystal**
- Crystal F (001)
- Colors**
- Plain Colors**
- Amethyst F (204)
- Crystal Effects**
- Transparent Effects**
- Crystal AB F (001 AB)
  - Crystal Blue Shade F (001 BLSH)
  - Crystal Silver Night F (001 SINI)

<b>Size</b>			
	6x4.8 mm	10x8 mm	14x11 mm

2205 Flame Flat Back

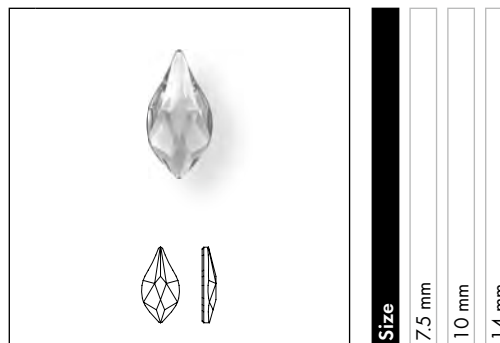

- Crystal**
- Crystal F (001)
- Colors**
- Plain Colors**
- Fireopal F (237)
  - Jet (280)
  - Light Colorado Topaz F (246)
  - Light Siam F (227)
- Opal Colors**
- White Opal F (234)
- Crystal Effects**
- Transparent Effects**
- Crystal AB F (001 AB)
  - Crystal Golden Shadow F (001 GSHA)
  - Crystal Silver Night (001 SINI)
- Metallic Effects**
- Crystal Iridescent Green F (001 IRIG)

<b>Size</b>			
	7.5 mm	10 mm	14 mm

# FLAT BACKS NO HOTFIX

## 2300 Drop Flat Back



<b>Crystal</b>		
Crystal F (001)	■	■
<b>Crystal Effects</b>		
<b>Metallic Effects</b>		
Crystal Light Chrome F (001 LTCH)	■	■

**Size**  
8x4.8 mm  
10x6 mm

## 2304 Raindrop Flat Back

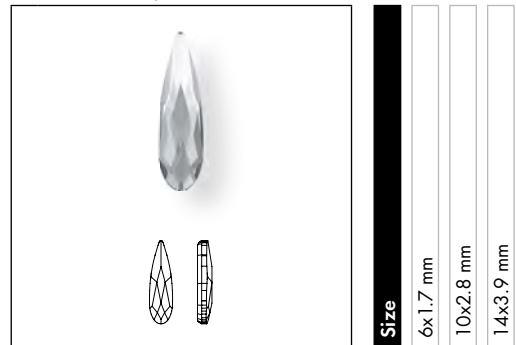

<b>Crystal</b>			
Crystal F (001)	■	■	■
<b>Colors</b>			
<b>Plain Colors</b>			
Blush Rose F (257)	■	■	■
Jet (280)	■	■	■
Light Siam F (227)	■	■	■
<b>Crystal Effects</b>			
<b>Transparent Effects</b>			
Crystal AB F (001 AB)	■	■	■
Crystal Blue Shade F (001 BLSH)	■	■	■
Crystal Golden Shadow F (001 GSHA)	■	■	■
Crystal Luminous Green F (001 LUMG)	■	■	■
Crystal Silver Night (001 SINI)	■	■	■

**Size**  
6x1.7 mm  
10x2.8 mm  
14x3.9 mm

## 2400 Square Flat Back

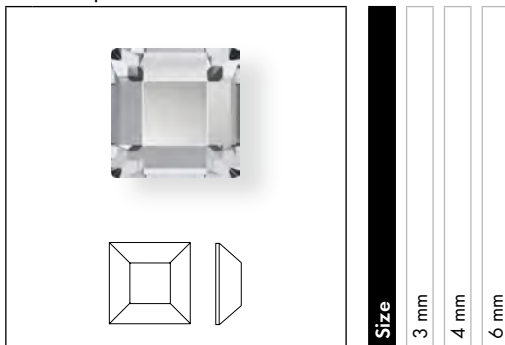

<b>Crystal</b>			
Crystal F (001)	■	■	■
<b>Colors</b>			
<b>Plain Colors</b>			
Graphite F (253)	■	■	■
<b>Crystal Effects</b>			
<b>Metallic Effects</b>			
Crystal Light Chrome F (001 LTCH)	■	■	■

**Size**  
3 mm  
4 mm  
6 mm

## 2420 Asymmetric Square Flat Back<sup>1</sup>

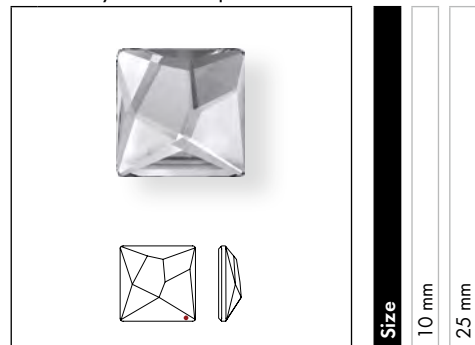

<b>Crystal</b>		
Crystal F (001)	■	■
Crystal CAL V SI (001 CAL V SI)	■	■
<b>Crystal Effects</b>		
<b>Transparent Effects</b>		
Crystal Bermuda Blue F (001 BBL)	■	■

**Size**  
10 mm  
25 mm

<sup>1</sup> Articles integrated from the former Bath & Wellness Collection may be partly delivered with a laser-engraved logo.

• The logo position is marked by a red dot.

<sup>2</sup> Coated on faceted side.



# FLAT BACKS NO HOTFIX

## 2483 Classic Square Flat Back

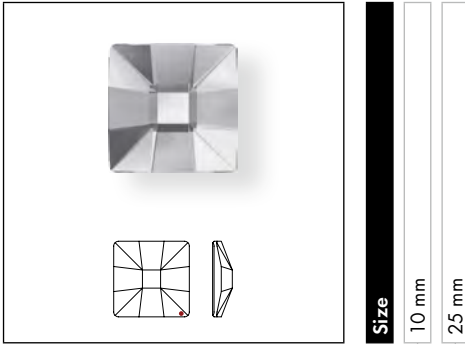

Crystal	
Crystal F (001)	■ ■
Crystal CAL SI (001 CAL SI) <sup>1+2</sup>	■ ■
Crystal CAL V SI (001 CAL V SI) <sup>1</sup>	■ ■
Colors	
Plain Colors	
Jet (280)	■

## 2493 Chessboard Flat Back

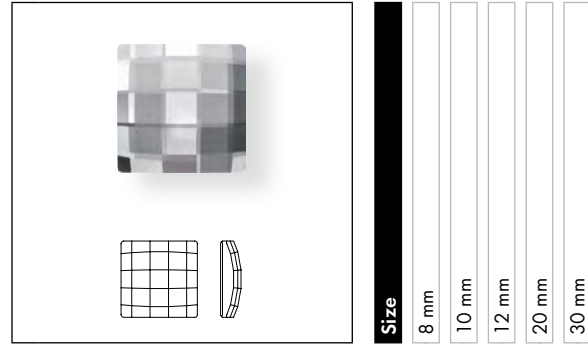

Crystal	
Crystal F (001)	■ ■ ■ ■ ■
Colors	
Plain Colors	
Black Diamond F (215)	■ ■ ■
Jet F (280)	■ ■ ■
Crystal Effects	
Transparent Effects	
Crystal AB F (001 AB)	■ ■ ■
Crystal Golden Shadow F (001 GSHA)	■ ■
Crystal Patina Effect	
Crystal Black Patina F (001 BLAPA)	■ ■ ■
Crystal Gold Patina F (001 GOLPA)	■ ■ ■
Crystal Rose Patina F (001 ROSPA)	■ ■ ■
Crystal Silver Patina F (001 SILPA)	■ ■ ■
Crystal White Patina F (001 WHIPA)	■ ■ ■

<sup>1</sup> Articles integrated from the former Bath & Wellness Collection may be partly delivered with a laser-engraved logo.

• The logo position is marked by a red dot.

<sup>2</sup> Coated on faceted side.

# FLAT BACKS NO HOTFIX

## 2494 Starlet Flat Back

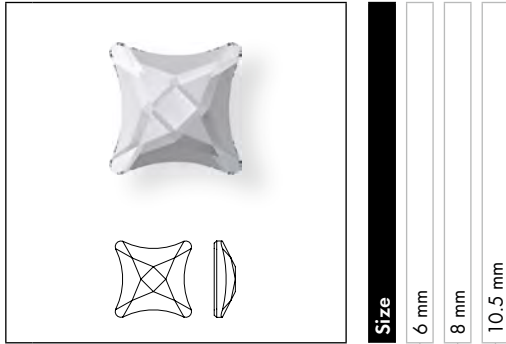

**Size**  
6 mm  
8 mm  
10.5 mm

Crystal		
Crystal F (001)	■	■
Colors		
Plain Colors		
Jet (280)	■	■
Light Siam F (227)	■	■
Light Turquoise F (263)	■	■
Smoky Mauve F (265)	■	■
Crystal Effects		
Transparent Effects		
Crystal AB F (001 AB)	■	■
Crystal Bermuda Blue F (001 BBL)	■	■
Crystal Golden Shadow F (001 GSHA)	■	■
Crystal Luminous Green F (001 LUMG)	■	■
Crystal Paradise Shine F (001 PARSH)	■	■
Crystal Silver Night F (001 SINI)	■	■

## 2520 Cosmic Flat Back

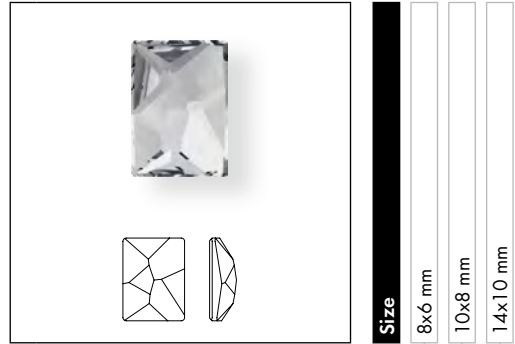

**Size**  
8x6 mm  
10x8 mm  
14x10 mm

Crystal		
Crystal F (001)	■	■
Colors		
Plain Colors		
Jet (280)	■	■
Crystal Effects		
Transparent Effects		
Crystal AB F (001 AB)	■	■
Crystal Golden Shadow F (001 GSHA)	■	■

# FLAT BACKS NO HOTFIX

## 2540 Curvy Flat Back

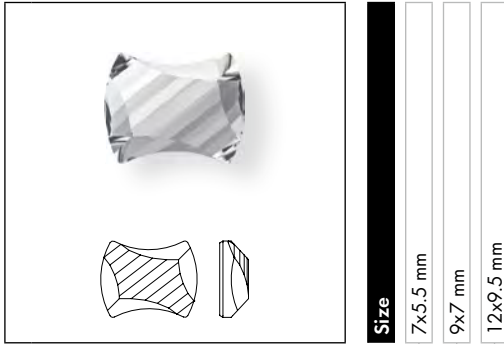

**Size**  
7x5.5 mm  
9x7 mm  
12x9.5 mm

<b>Crystal</b>		
Crystal F (001)	■	■
<b>Colors</b>		
<b>Plain Colors</b>		
Jet (280)	■	■
Light Siam F (227)	■	■
Light Turquoise F (263)	■	■
Smoky Mauve F (265)	■	■
Rose Peach F (262)	■	■
<b>Crystal Effects</b>		
<b>Transparent Effects</b>		
Crystal AB F (001 AB)	■	■
Crystal Bermuda Blue F (001 BBL)	■	■
Crystal Golden Shadow F (001 GSHA)	■	■
Crystal Luminous Green F (001 LUMG)	■	■
Crystal Paradise Shine F (001 PARSH)	■	■
Crystal Silver Night F (001 SINI)	■	■

## 2555 Cosmic Baguette Flat Back

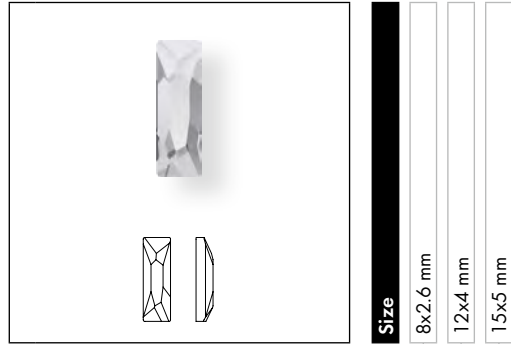

**Size**  
8x2.6 mm  
12x4 mm  
15x5 mm

<b>Crystal</b>		
Crystal F (001)	■	■
<b>Colors</b>		
<b>Plain Colors</b>		
Jet (280)	■	■
<b>Crystal Effect</b>		
<b>Transparent Effects</b>		
Crystal Golden Shadow F (001 GSHA)	■	■

## 2570 Vigour Rectangle Flat Back <sup>1</sup>

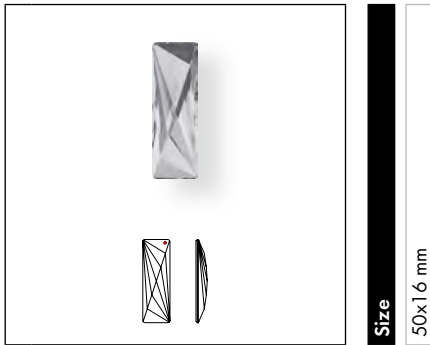

**Size**  
50x16 mm

<b>Crystal</b>		
Crystal F (001)	■	
Crystal CAL SI (001 CAL SI) <sup>1+2</sup>	■	
Crystal CAL V SI (001 CAL V SI) <sup>1</sup>	■	

<sup>1</sup> Articles integrated from the former Bath & Wellness Collection may be partly delivered with a laser-engraved logo.

• The logo position is marked by a red dot.

<sup>2</sup> Coated on faceted side.

# FLAT BACKS NO HOTFIX

## 2585 Graphic Flat Back

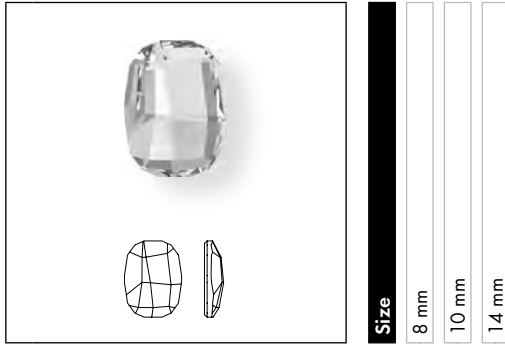

**Crystal**

Crystal F (001)

**Crystal Effects**

**Transparent Effects**

Crystal AB F (001 AB)

## 2611 Solaris Flat Back

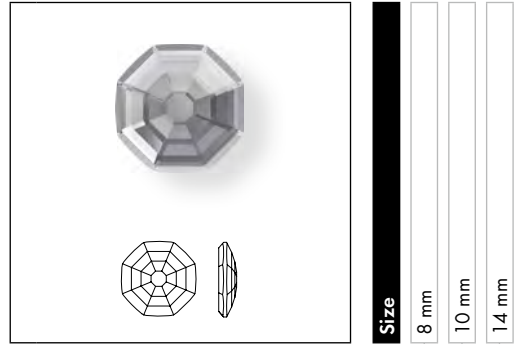

**Crystal**

Crystal F (001)

**Colors**

Light Rose F (223)

**Crystal Effects**

**Transparent Effects**

Crystal AB F (001 AB)

Crystal Golden Shadow F (001 GSHA)

Crystal Luminous Green F (001 LUMG)

Crystal Silver Night F (001 SINI)

OCEAN MYSTERIES DESIGNED  
BY CÉLINE COUSTEAU

**Design Story:** A love for the sea runs through her veins: Céline Cousteau is a celebrated filmmaker, humanitarian, and environmentalist, and, as it so happens, the granddaughter of legendary ocean explorer Jacques Yves Cousteau. She presents her first ever crystal designs for Swarovski, inspired by one of her favorite places, the depths of the ocean. Taking inspiration from nature itself

and leaving its beauty unaltered, her stunningly life-like creatures are not only captivating and spellbinding, they also draw attention toward the mysterious, mostly unseen, and unexplored world beneath the ocean's surface on which all ocean life depends. These mysteries need to be protected for future generations, both above and below the water.

07 FLAT BACKS NO HOTFIX

2612 Jelly Fish Flat Back partly frosted No Hotfix

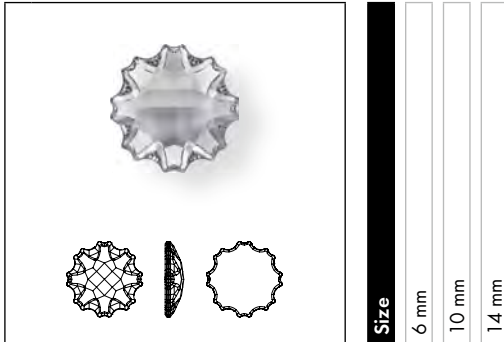

Size	6 mm	10 mm	14 mm
------	------	-------	-------

Crystal	6 mm	10 mm	14 mm
Crystal F (001)	■	■	■
<b>Colors</b>			
<b>Plain Colors</b>			
Blush Rose F (257)	■	■	■
Jet (280)	■	■	■
Tanzanite F (539)	■	■	■
<b>Opal Colors</b>			
White Opal F (234)	■	■	■
<b>Crystal Effects</b>			
<b>Transparent Effects</b>			
Crystal AB F (001 AB)	■	■	■
Crystal Bermuda Blue F (001 BBL)	■	■	■
Crystal Blue Shade F (001 BLSH)	■	■	■
Crystal Golden Shadow F (001 GSHA)	■	■	■
Crystal Luminous Green F (001 LUMG)	■	■	■
Crystal Silver Night (001 SINI)	■	■	■

THE CÉLINE COUSTEAU  
DESIGNER EDITION FAMILY



**1695** chapter 01 Round Stones  
10, 14 mm p. 86



**1695/S** chapter 01 Round Stones  
10, 14 mm p. 86



**2612** chapter 07 Flat Backs No Hotfix  
6, 10, 14 mm p. 360



**2612** chapter 08 Flat Backs Hotfix  
6, 10, 14 mm p. 396



**4195** chapter 02 Fancy Stones & Settings  
14, 18, 22 mm p. 103



**4195/S** chapter 02 Fancy Stones & Settings  
14, 18, 22 mm p. 103



**6730** chapter 06 Pendants  
18x11.5, 34x22 mm p. 321



**6731** chapter 06 Pendants  
14, 28 mm p. 322

DESIGNER EDITIONS - DISTINCT PACKAGING

This Designer Edition will be labelled with the  
"Designer Edition" imprint directly on the packaging.

# FLAT BACKS NO HOTFIX

## 2708 Molecule Flat Back

**Size**  
8x8.7 mm  
12.5x13.6 mm

**Crystal**  
Crystal F (001)

## 2709 Rhombus Flat Back

**Size**  
10x6 mm  
13x8 mm

**Crystal**  
Crystal F (001)

**Colors**

**Plain Colors**

- Aquamarine F (202)
- Black Diamond F (215)
- Light Rose F (223)
- Light Siam F (227)

**Crystal Effects**

**Transparent Effects**

- Crystal AB F (001 AB)
- Crystal Golden Shadow F (001 GSHA)
- Crystal Silver Shade F (001 SSHA)

# FLAT BACKS NO HOTFIX

## 2714 Fan Flat Back

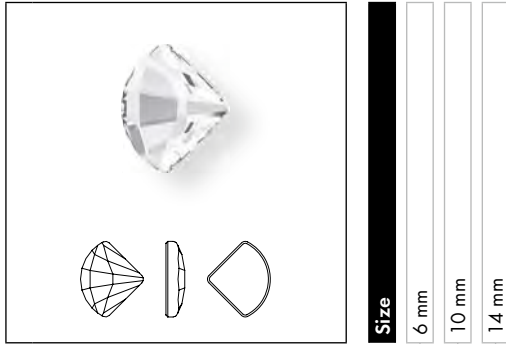

Size  
6 mm  
10 mm  
14 mm

### Crystal

Crystal F (001)

### Colors

#### Plain Colors

Blush Rose F (257)  
Jet (280)  
Jonquil F (213)  
Light Siam F (227)  
Rose Peach F (262)

### Crystal Effects

#### Transparent Effects

Crystal AB F (001 AB)  
Crystal Blue Shade F (001 BLSH)  
Crystal Golden Shadow F (001 GSHA)  
Crystal Silver Night (001 SINI)

### Crystal Effects

#### Metallic Effects

Crystal Metallic Sunshine F (001 METSH)  
Crystal Scarabaeus Green\*\*\* F (001 SCGR)

## 2716 Rivoli Triangle Flat Back

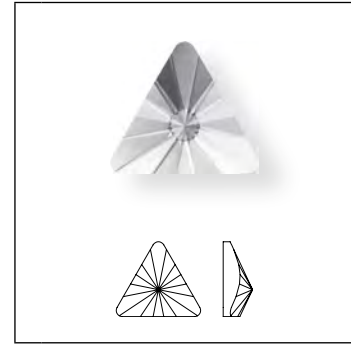

Size  
5 mm

### Crystal

Crystal F (001)

### Crystal Effect

Transparent Effects  
Crystal AB F (001 AB)

## 2720 Cosmic Delta Flat Back

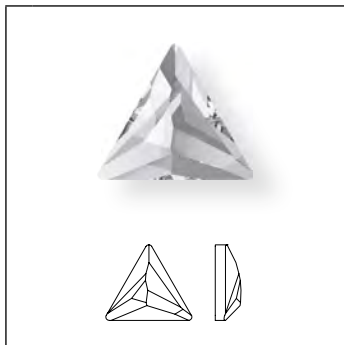

Size  
7.5 mm  
9 mm  
12.5 mm

### Crystal

Crystal F (001)



# FLAT BACKS NO HOTFIX

07 FLAT BACKS NO HOTFIX

## 2738 Triangle Alpha Flat Back

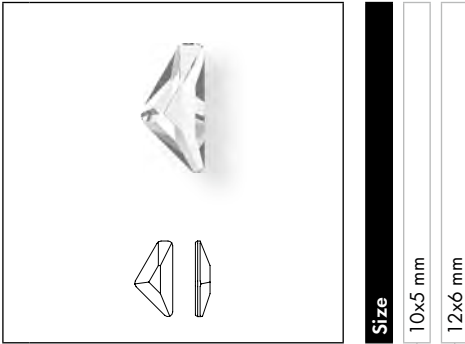

Size

10x5 mm

12x6 mm

### Crystal

Crystal F (001)

### Colors

#### Plain Colors

Blush Rose F (257)

Jet (280)

Light Colorado Topaz F (246)

Light Sapphire F (211)

Light Siam F (227)

### Crystal Effects

#### Transparent Effects

Crystal AB F (001 AB)

Crystal Golden Shadow F (001 GSHA)

Crystal Silver Night (001 SINI)

### Crystal Lacquer<sup>PRO</sup>

Crystal Dark Grey (001 L111S)

Crystal Dark Red (001 L108S)

Crystal Ivory Cream (001 L106S)

## 2739 Triangle Beta Flat Back

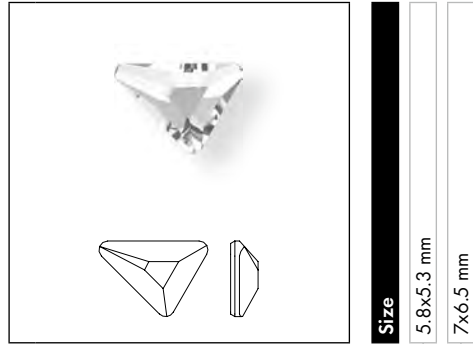

Size

5.8x5.3 mm

7x6.5 mm

### Crystal

Crystal F (001)

### Colors

#### Plain Colors

Blush Rose F (257)

Jet (280)

Light Colorado Topaz F (246)

Light Sapphire F (211)

Light Siam F (227)

### Crystal Effects

#### Transparent Effects

Crystal AB F (001 AB)

Crystal Golden Shadow F (001 GSHA)

Crystal Silver Night (001 SINI)

### Crystal Lacquer<sup>PRO</sup>

Crystal Dark Grey (001 L111S)

Crystal Dark Red (001 L108S)

Crystal Ivory Cream (001 L106S)

# FLAT BACKS NO HOTFIX

## 2740 Triangle Gamma Flat Back

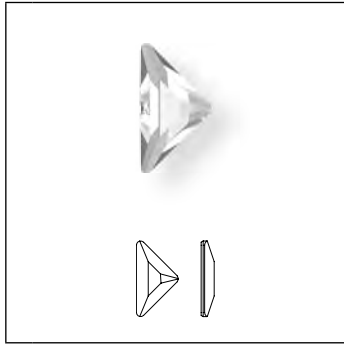

**Size**

8.3x8.3 mm

10x10 mm

### Crystal

Crystal F (001)

### Colors

#### Plain Colors

Blush Rose F (257)

Jet (280)

Light Colorado Topaz F (246)

Light Sapphire F (211)

Light Siam F (227)

### Crystal Effects

#### Transparent Effects

Crystal AB F (001 AB)

Crystal Golden Shadow F (001 GSHA)

Crystal Silver Night (001 SINI)

### Crystal Lacquer<sup>PRO</sup>

Crystal Dark Grey (001 L111S)

Crystal Dark Red (001 L108S)

Crystal Ivory Cream (001 L106S)

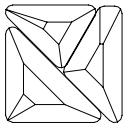

Alpha, Beta & Gamma FBs  
create together a square.

# FLAT BACKS NO HOTFIX

07 FLAT BACKS NO HOTFIX

## 2753 Edelweiss Flat Back

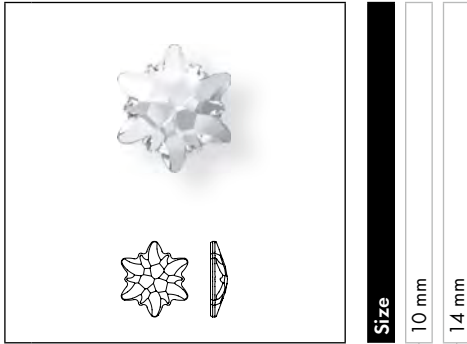

**Size**  
10 mm  
14 mm

- Crystal**
- Crystal F (001)
- Colors**
- Plain Colors**
- Amethyst F (204)
- Denim Blue F (266)
- Light Siam F (227)
- Vintage Rose F (319)
- Opal Colors**
- White Opal F (234)
- Crystal Effects**
- Transparent Effects**
- Crystal AB F (001 AB)
- Crystal Blue Shade F (001 BLSH)
- Crystal Golden Shadow F (001 GSHA)
- Crystal Luminous Green F (001 LUMG)
- Crystal Silver Night (001 SINI)
- Metallic Effects**
- Crystal Metallic Sunshine F (001 METSH)

## 2753/G Edelweiss Flat Back partly frosted



**Size**  
10 mm  
14 mm

- Crystal**
- Crystal F (001)
- Crystal Effects**
- Transparent Effects**
- Crystal AB F (001 AB)
- Crystal Blue Shade F (001 BLSH)
- Crystal Golden Shadow F (001 GSHA)
- Crystal Luminous Green F (001 LUMG)
- Crystal Silver Night (001 SINI)
- Metallic Effects**
- Crystal Metallic Sunshine F (001 METSH)

## 2770 Wing Flat Back

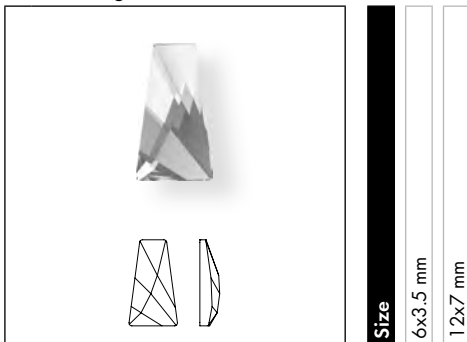

**Size**  
6x3.5 mm  
12x7 mm

- Crystal**
- Crystal F (001)
- Color**
- Plain Color**
- Black Diamond F (215)
- Crystal Effects**
- Transparent Effects**
- Crystal Golden Shadow F (001 GSHA)
- Crystal Silver Shade F (001 SSHA)

## 2788 Wave Flat Back



**Size**  
8 mm  
10 mm

- Crystal**
- Crystal F (001)

DIAMOND LEAF <sup>1</sup>



Swarovski and Giorgio Armani worked together to create an exclusive crystal called "Diamond Leaf". This Designer Edition has a fluid, organic shape reminiscent of a leaf. Precision cut facets melt into the softness of a floating, sculptural form, contrasting strength and fragility, the timeless with the ethereal.

**Giorgio Armani: "Swarovski crystal brings a touch of magic to a dress, an ethereal quality, a lustre which never fails to captivate the attention."**

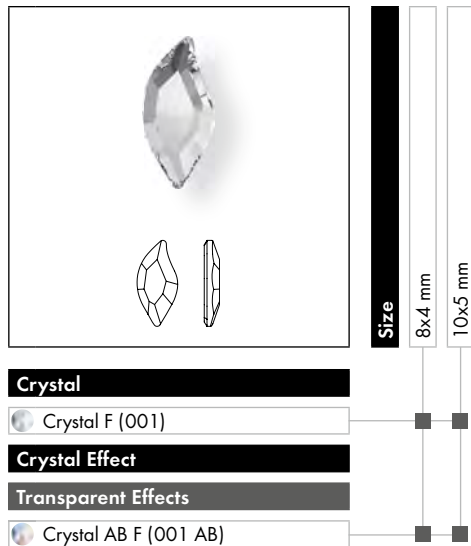
2797 Diamond Leaf Flat Back <sup>1</sup>



THE DIAMOND LEAF DESIGNER EDITION FAMILY

- 
**2797** 8x4, 10x5 mm chapter 07 Flat Back No Hotfix p. 367
- 
**2797** 8x4 mm chapter 08 Flat Back Hotfix p. 403
- 
**3254** 20x9, 30x14 mm chapter 09 Sew-on Articles p. 421

DESIGNER EDITIONS - DISTINCT PACKAGING

This Designer Edition will be labelled with the "Designer Edition" imprint directly on the packaging.

<sup>1</sup> Article consists of Advanced Crystal

# FLAT BACKS NO HOTFIX

## 2798 Contour Flat Back

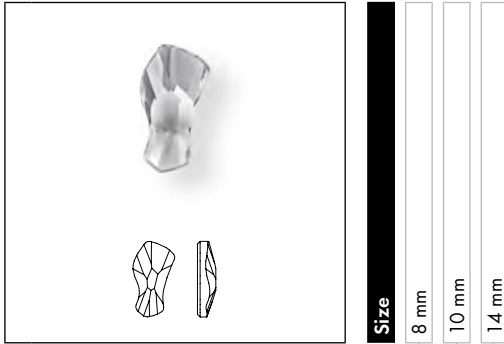

Size  
8 mm  
10 mm  
14 mm

Crystal	8 mm	10 mm	14 mm
Crystal F (001)	■	■	■
<b>Colors</b>			
<b>Plain Colors</b>			
Graphite F (253)	■	■	■
Jet (280)	■	■	■
Light Colorado Topaz F (246)	■	■	■
Light Silk F (261)	■	■	■
<b>Opal Colors</b>			
Light Grey Opal F (383)	■	■	■
White Opal F (234)	■	■	■
<b>Crystal Effects</b>			
<b>Transparent Effects</b>			
Crystal AB F (001 AB)	■	■	■
Crystal Blue Shade F (001 BLSH)	■	■	■
Crystal Golden Shadow F (001 GSHA)	■	■	■
Crystal Silver Night (001 SINI)	■	■	■
<b>Metallic Effects</b>			
Crystal Iridescent Green F (001 IRIG)	■	■	■

## 2808 Heart Flat Back

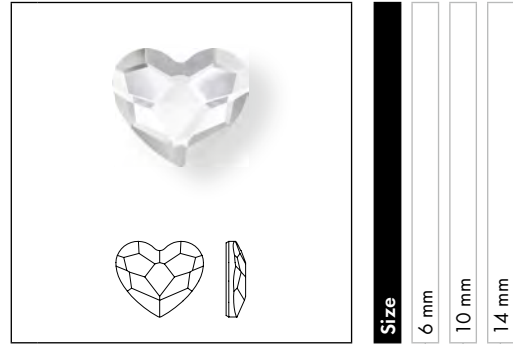

Size  
6 mm  
10 mm  
14 mm

Crystal	6 mm	10 mm	14 mm
Crystal F (001)	■	■	■
<b>Colors</b>			
<b>Plain Colors</b>			
Denim Blue F (266)	■	■	■
Fuchsia F (502)	■	■	■
Jet (280)	■	■	■
Light Siam F (227)	■	■	■
Light Silk F (261)	■	■	■
Rosaline F (508)	■	■	■
<b>Crystal Effects</b>			
<b>Transparent Effects</b>			
Crystal AB F (001 AB)	■	■	■
Crystal Antique Pink F (001 ANTP)	■	■	■
Crystal Golden Shadow F (001 GSHA)	■	■	■
<b>Crystal Lacquer<sup>PRO</sup></b>			
Crystal Powder Blue (001 L104)	■	■	■
Crystal Powder Green (001 L102)	■	■	■
Crystal Powder Rose (001 L103)	■	■	■
<b>Crystal Patina Effect</b>			
Crystal Black Patina F (001 BLAPA)	■	■	■
Crystal Gold Patina F (001 GOLPA)	■	■	■
Crystal Rose Patina F (001 ROSPA)	■	■	■
Crystal Silver Patina F (001 SILPA)	■	■	■
Crystal White Patina F (001 WHIPA)	■	■	■

# FLAT BACKS NO HOTFIX

## 2813 Moon Flat Back

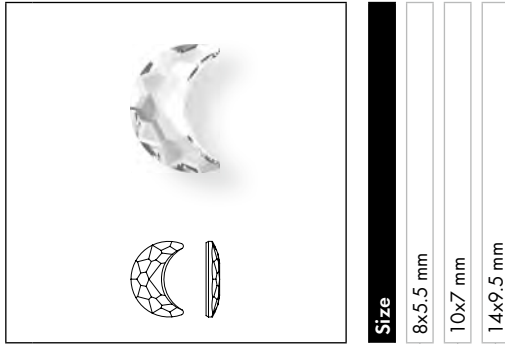

Size

8x5.5 mm  
10x7 mm  
14x9.5 mm

### Crystal

Crystal F (001)

### Colors

#### Plain Colors

Blush Rose F (257)

Jet (280)

Light Colorado Topaz F (246)

Light Siam F (227)

### Crystal Effects

#### Transparent Effects

Crystal AB F (001 AB)

Crystal Golden Shadow F (001 GSHA)

Crystal Luminous Green F (001 LUMG)

Crystal Moonlight F (001 MOL)

Crystal Silver Night F (001 SINI)

### Crystal Effects

#### Metallic Effects

Crystal Metallic Sunshine F (001 METSH)

Crystal Scarabaeus Green\*\*\* F (001 SCGR)

## 2816 Rivoli Star Flat Back

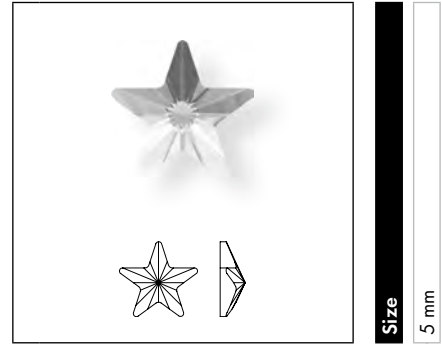

Size

5 mm

### Crystal

Crystal F (001)

### Crystal Effects

#### Transparent Effects

Crystal AB F (001 AB)

## 2826 Rivoli Snowflake Flat Back

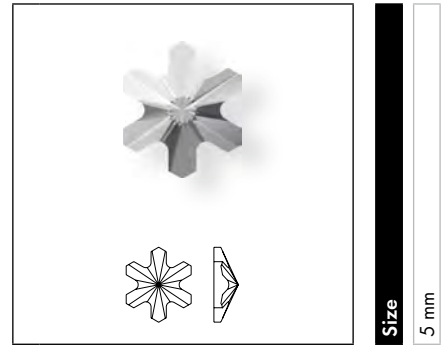

Size

5 mm

### Crystal

Crystal F (001)

### Crystal Effects

#### Transparent Effects

Crystal AB F (001 AB)

\*\*\* designed by Jean Paul Gaultier

# FLAT BACKS NO HOTFIX

07 FLAT BACKS NO HOTFIX

## 2854 Butterfly Flat Back

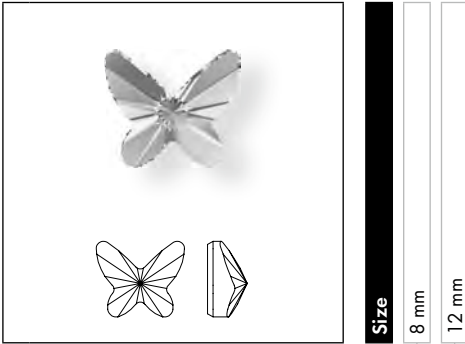

**Size**  
8 mm  
12 mm

Crystal		
Crystal F (001)	<input type="checkbox"/>	<input type="checkbox"/>
Colors		
Plain Colors		
Amethyst F (204)	<input type="checkbox"/>	<input type="checkbox"/>
Denim Blue F (266)	<input type="checkbox"/>	<input type="checkbox"/>
Light Rose F (223)	<input type="checkbox"/>	<input type="checkbox"/>
Crystal Effects		
Transparent Effects		
Crystal AB F (001 AB)	<input type="checkbox"/>	<input type="checkbox"/>
Crystal Antique Pink F (001 ANTP)	<input type="checkbox"/>	<input type="checkbox"/>
Crystal Golden Shadow F (001 GSHA)	<input type="checkbox"/>	<input type="checkbox"/>
Crystal Silver Night F (001 SINI)	<input type="checkbox"/>	<input type="checkbox"/>

## 2858 Bow Tie Flat Back

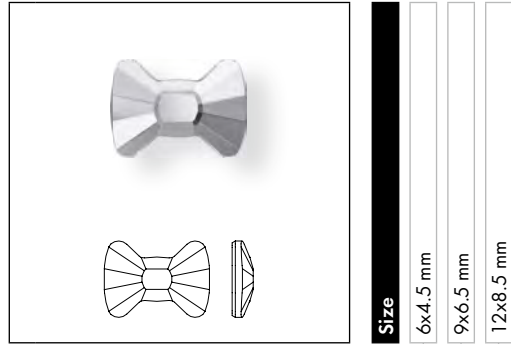

**Size**  
6x4.5 mm  
9x6.5 mm  
12x8.5 mm

Crystal		
Crystal F (001)	<input type="checkbox"/>	<input type="checkbox"/>
Colors		
Plain Colors		
Denim Blue F (266)	<input type="checkbox"/>	<input type="checkbox"/>
Jet (280)	<input type="checkbox"/>	<input type="checkbox"/>
Light Amethyst F (212)	<input type="checkbox"/>	<input type="checkbox"/>
Light Siam F (227)	<input type="checkbox"/>	<input type="checkbox"/>
Tangerine F (259)	<input type="checkbox"/>	<input type="checkbox"/>
Vintage Rose F (319)	<input type="checkbox"/>	<input type="checkbox"/>
Opal Colors		
White Opal F (234)	<input type="checkbox"/>	<input type="checkbox"/>
Crystal Effects		
Transparent Effects		
Crystal AB F (001 AB)	<input type="checkbox"/>	<input type="checkbox"/>
Crystal Golden Shadow F (001 GSHA)	<input type="checkbox"/>	<input type="checkbox"/>
Crystal Luminous Green F (001 LUMG)	<input type="checkbox"/>	<input type="checkbox"/>
Crystal Paradise Shine F (001 PARSH)	<input type="checkbox"/>	<input type="checkbox"/>
Crystal Silver Night F (001 SINI)	<input type="checkbox"/>	<input type="checkbox"/>
Crystal Lacquer <sup>PRO</sup>		
Crystal Powder Blue (001 L104)	<input type="checkbox"/>	<input type="checkbox"/>
Crystal Powder Rose (001 L103)	<input type="checkbox"/>	<input type="checkbox"/>

# FLAT BACKS NO HOTFIX

## PRODUCT DETAILS

Article Size	Packing Unit = Minimum Order Quantity in Pieces	Average Net Weight in Grams per Packing Unit Crystal (001)	Average Gross Weight in Grams per Packing Unit Crystal (001)
<b>2000</b>			
SS 3	1,440	1.8	12.7
SS 4	1,440	3.3	13.7
<b>2006</b>			
10 mm	288	89.9	116.4
12 mm	144	87.2	110.9
14 mm	144	132.4	158.7
16 mm	144	188.6	222.4
<b>2034</b>			
SS 10	1440	10.9	19.3
SS 20	1440	40.7	49.2
SS 48	96	39.8	64.8
<b>2035</b>			
6 mm	360	27.1	34.8
10 mm	192	56.2	88.0
14 mm	96	88.4	109.0
20 mm	40	82.0	121.4
30 mm	12	95.4	130.8
40 mm	6	105.3	140.3
<b>2037</b>			
8 mm	240	14.5	23.6
14 mm	72	12.1	40.0
17 mm	72	27.7	52.2
<b>2058</b>			
SS 5	1,440	4.4	17.9
SS 6	1,440	5.7	17.6
SS 7	1,440	7.1	19.0
SS 8	1,440	10.1	19.6
SS 9	1,440	12.4	22.0
SS 10	1,440	15.8	25.3
<b>2072</b>			
8 mm	288	92.9	119.6
10 mm	144	90.6	111.0
12 mm	72	82.0	100.1
<b>2088</b>			
SS 12	1,440	22.1	30.3
SS 14	1,440	30.1	38.3
SS 16	1,440	39.9	49.8
SS 20	1,440	72.2	80.9
SS 30	288	34.6	63.0
SS 34	144	25.9	48.6
SS 40	144	50.0	75.1
SS 48	96	76.1	101.3
<b>2088/G</b>			
SS 20	1,440	71.2	82.7
SS 34	144	25.1	44.1
<b>2200</b>			
8x4 mm	720	49.6	60.2
<b>2204</b>			
6x4.8 mm	360	27.2	36.4
10x8 mm	144	31.5	53.3
14x11 mm	108	52.6	74.0



# FLAT BACKS NO HOTFIX

07 FLAT BACKS NO HOTFIX

Article Size	Packing Unit = Minimum Order Quantity in Pieces	Average Net Weight in Grams per Packing Unit Crystal (001)	Average Gross Weight in Grams per Packing Unit Crystal (001)
<b>2205</b>			
7.5 mm	288	20.3	30.5
10 mm	144	17.6	42.4
14 mm	72	22.3	45.9
<b>2300</b>			
8x4.8 mm	720	83.9	94.5
10x6 mm	360	56.9	67.8
<b>2304</b>			
10x2.8 mm	180	10.3	20.5
14x3.9 mm	96	13.1	36.3
6x1.7 mm	360	7.5	16.2
<b>2400</b>			
3 mm	1,440	25.3	36.8
4 mm	720	30.0	41.0
6 mm	144	21.6	32.5
<b>2420</b>			
10 mm	144	91.6	118.2
25 mm	32	200.8	251.8
<b>2483</b>			
10 mm	144	90.3	120.2
25 mm	32	233.3	261.5
<b>2493</b>			
8 mm	216	72.3	91.8
10 mm	144	84.4	106.1
12 mm	96	96.4	127.8
20 mm	24	108.5	137.9
30 mm	6	92.4	123.2
<b>2494</b>			
6 mm	220	22.3	31.5
8 mm	144	29.5	50.2
10.5 mm	96	42.7	63.8
<b>2520</b>			
8x6 mm	288	50.8	80.2
10x8 mm	144	72.3	90.4
14x10 mm	144	119.3	140.8
<b>2540</b>			
7x5.5 mm	240	39.7	43.6
9x7 mm	144	37.5	59.6
12x9.5 mm	96	66.7	78.3
<b>2555</b>			
8x2.6 mm	240	18.4	27.5
12x4 mm	144	28.8	33.6
15x5 mm	72	28.9	46.0
<b>2570</b>			
50x16 mm	6	52.9	81.6
<b>2585</b>			
8 mm	288	48.2	68.1
10 mm	288	72.3	104.3
14 mm	144	106.1	145.5

# FLAT BACKS NO HOTFIX

Article Size	Packing Unit = Minimum Order Quantity in Pieces	Average Net Weight in Grams per Packing Unit Crystal (001)	Average Gross Weight in Grams per Packing Unit Crystal (001)
<b>2611</b>			
8 mm	144	29.4	38.5
10 mm	216	93.6	115.9
14 mm	48	42.3	63.5
<b>2612</b>			
6 mm	72	5.9	16.1
10 mm	48	17.3	38.7
14 mm	36	33.1	53.8
<b>2708</b>			
8x8.7 mm	288	28.1	57.3
12.5x13.6 mm	96	49.3	69.3
<b>2709</b>			
10x6 mm	288	48.2	73.6
13x8 mm	144	41.0	60.1
<b>2714</b>			
6 mm	360	38.8	49.7
10 mm	144	59.8	84.3
14 mm	108	107.1	132.2
<b>2716</b>			
5 mm	720	35.8	75.1
<b>2720</b>			
7.5 mm	240	27.9	37.0
9 mm	180	45.1	54.2
12.5 mm	144	71.1	87.1
<b>2304</b>			
6x1.7 mm	360	7.5	16.2
<b>2738</b>			
10x5 mm	144	16.7	35.1
12x6 mm	96	20.2	38.3
<b>2739</b>			
5.8x5.3 mm	216	19.2	41.9
7x6.5 mm	144	22.6	39.8
<b>2740</b>			
8.3x8.3 mm	216	35.1	54.2
10x10 mm	96	25.1	41.1
<b>2753</b>			
10 mm	72	19.6	40.4
14 mm	36	20.2	40.8
<b>2753/G</b>			
10 mm	72	16.5	35.6
14 mm	36	21.1	41.7
<b>2770</b>			
6x3.5 mm	1,440	60.3	70.3
12x7 mm	192	49.8	98.4
<b>2788</b>			
8 mm	288	7.5	18.4
10 mm	216	10.5	37.8

# FLAT BACKS NO HOTFIX

07 FLAT BACKS NO HOTFIX

Article Size	Packing Unit = Minimum Order Quantity in Pieces	Average Net Weight in Grams per Packing Unit Crystal (001)	Average Gross Weight in Grams per Packing Unit Crystal (001)
<b>2797</b>			
8x4 mm	240	14.9	24.0
10x15 mm	180	23.4	32.6
<b>2798</b>			
8 mm	360	23.0	33.2
10 mm	144	21.4	44.7
14 mm	108	55.1	83.5
<b>2808</b>			
6 mm	288	19.8	28.9
10 mm	144	38.8	55.9
14 mm	96	56.4	86.8
<b>2813</b>			
8x5.5 mm	144	13.1	37.7
10x7 mm	144	23.0	47.6
14x9.5 mm	72	35.4	60.5
<b>2816</b>			
5 mm	720	23.6	30.7
<b>2826</b>			
5 mm	720	23.1	30.1
<b>2854</b>			
8 mm	216	36.0	52.2
12 mm	144	84.4	103.8
<b>2858</b>			
6x4.5 mm	240	12.5	21.7
9x6.5 mm	144	23.4	44.1
12x8.5 mm	96	28.7	49.8

FLAT BACKS NO HOTFIX